

SAF RAIL™

FIELD FABRICATION GUIDE

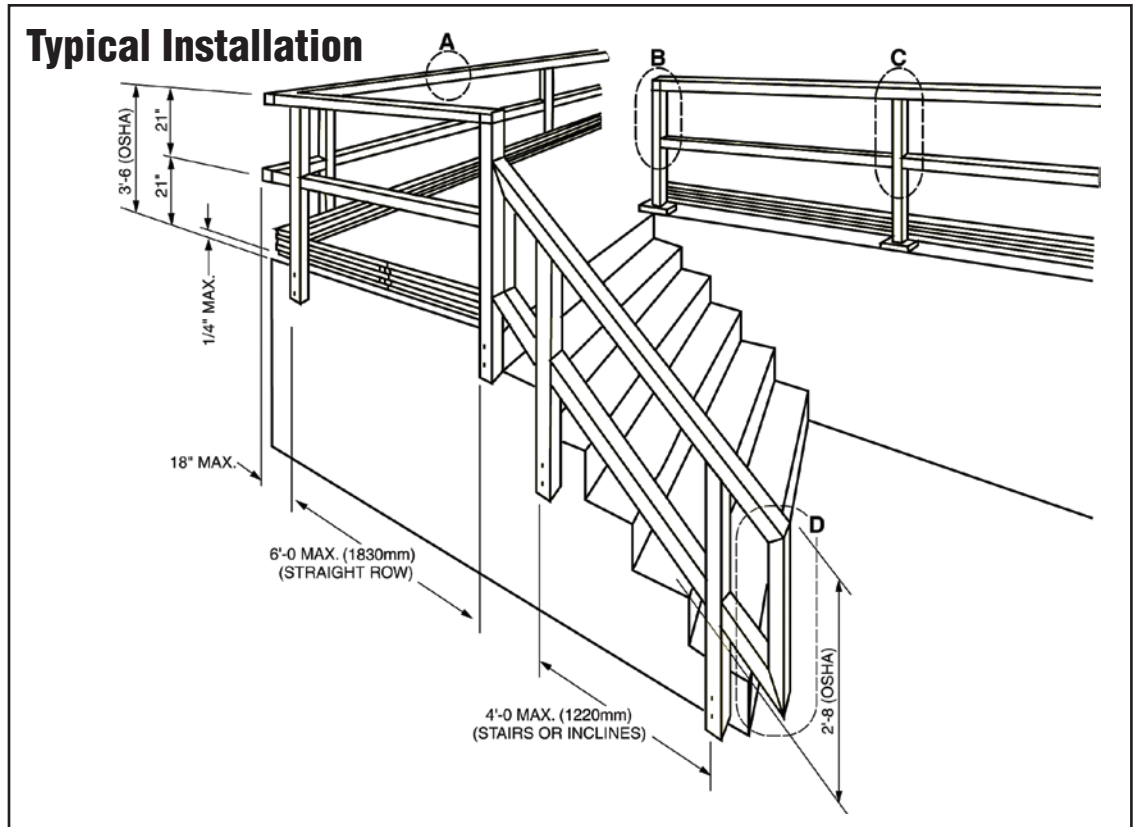

Connection Details All components secured with epoxy.

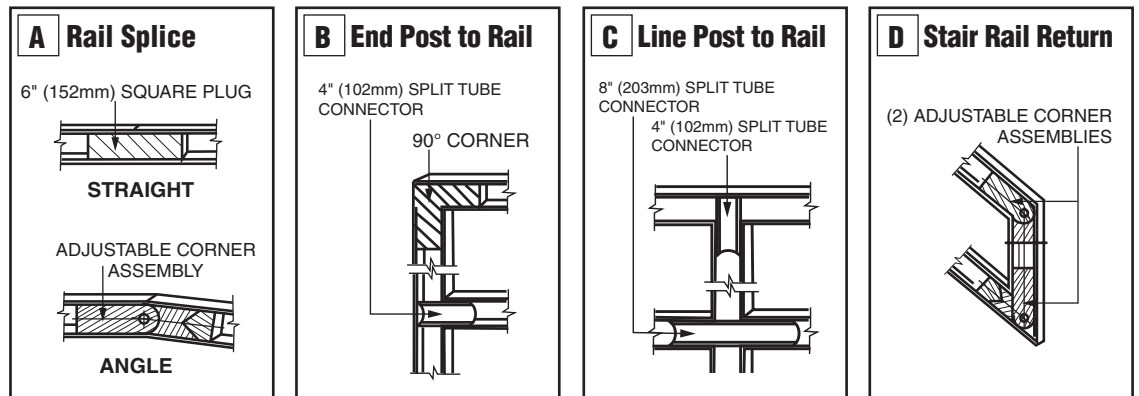

Suggested Post and Kick Plate Installation

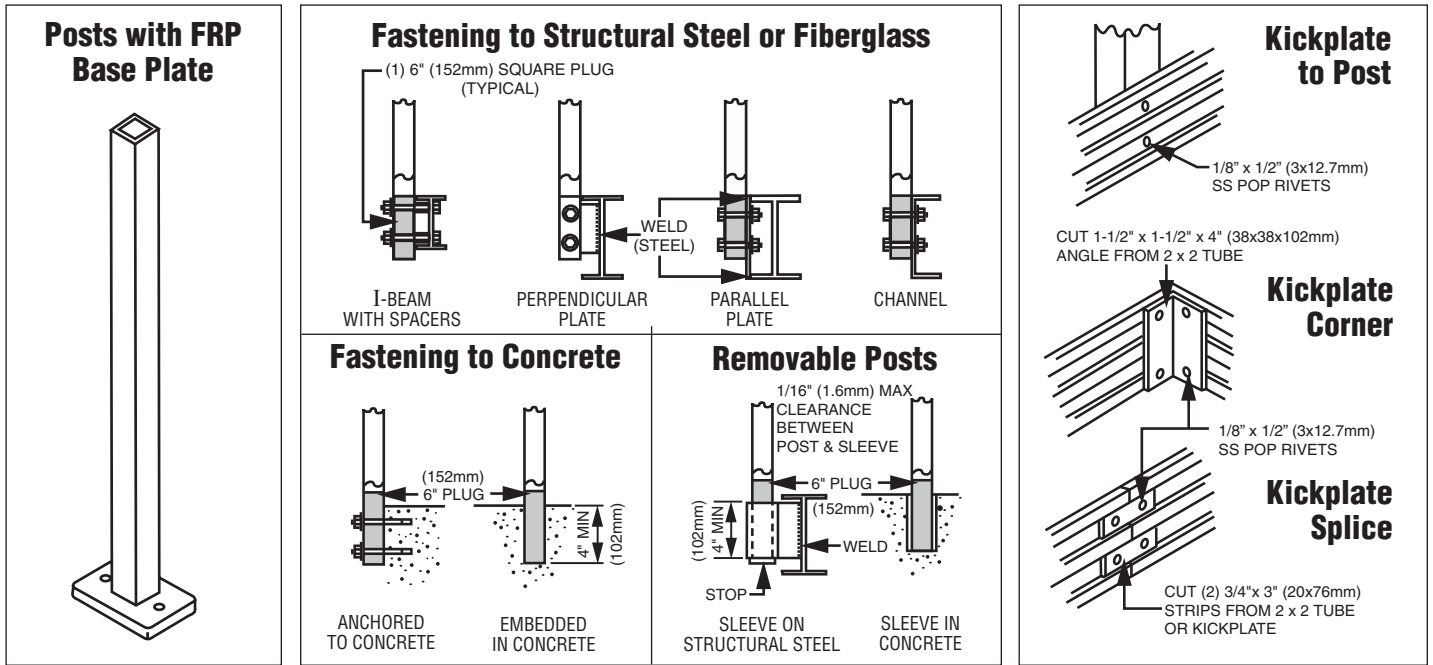

Fabrication Methods

1. Cut components to length and miter where necessary.

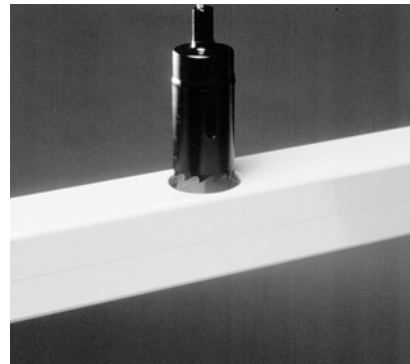
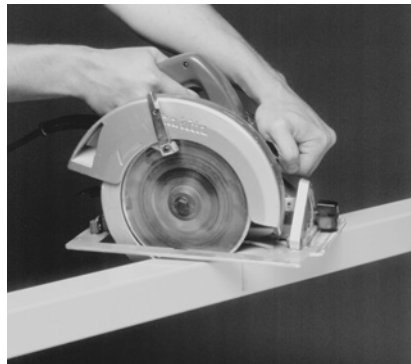

2. Locate and drill holes for split tube connector. Must use 1.68" (42.7mm) dia. core drill (available from the Chatfield Location).

3. Apply recommended epoxy adhesive to connectors and inside tube (available from the Chatfield Location).

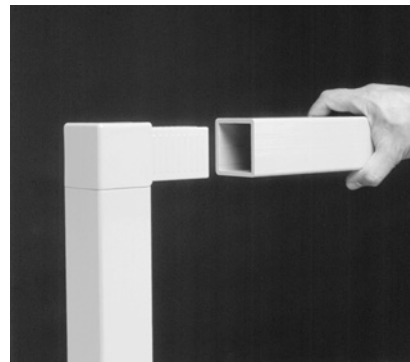
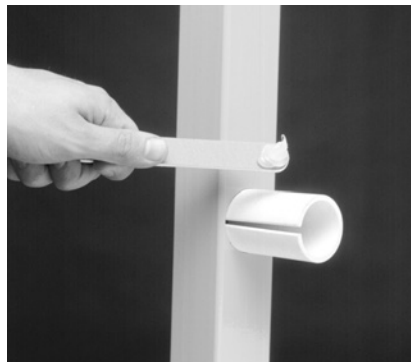

4. Press together. Wipe off excess adhesive. 1/8" (3.2mm) tension pins recommended at connections for field fabrication.

NOTE: Joints must be immobilized until cured. The recommended temperature for epoxy cure is 60°F (15.6°C) or above. Failure to use these installation and fabrication methods, including recommended epoxy adhesive and 1.68" (42.7mm) dia. core drill, may cause failure.

Basic SAFRAIL™ Components

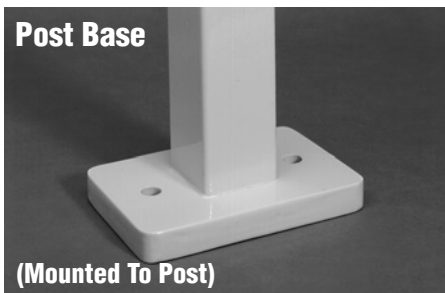
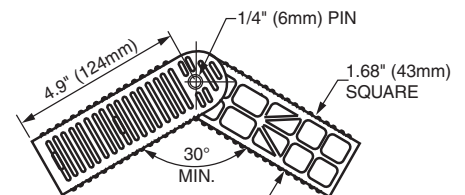
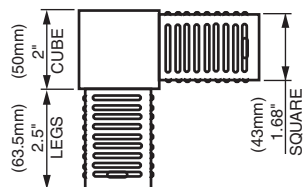
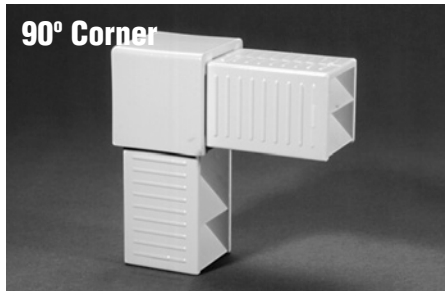
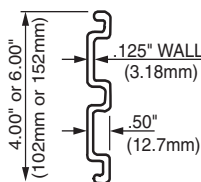
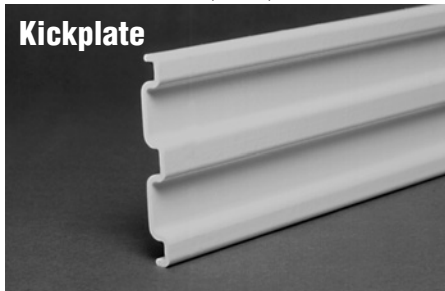
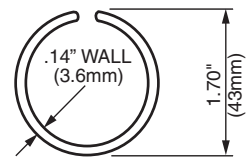
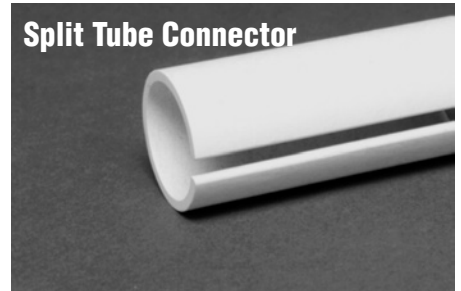
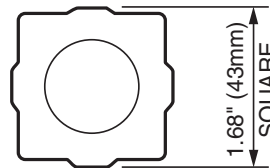
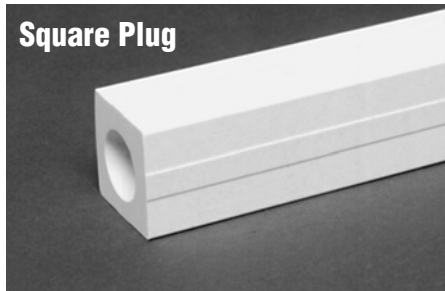
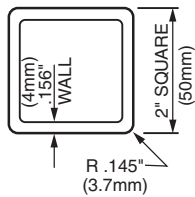
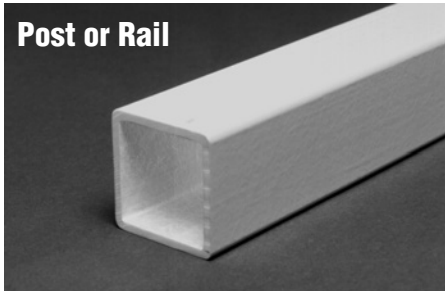

(Mounted To Post)

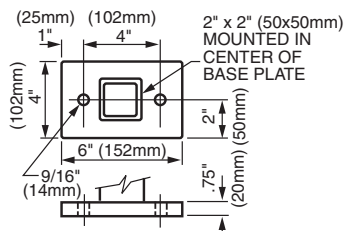

Note: For Capping Tubes (Special Construction)

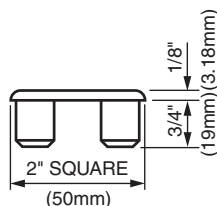

Supplementary Components

- SS Rivets
- 1/8" x 1-1/2" (3.2 x 38.1mm) Tension Pins
- Two-Part Epoxy Kits
- Mounting Bolts
- Kickplate Splice and Corner Connectors

Alternative Post Design

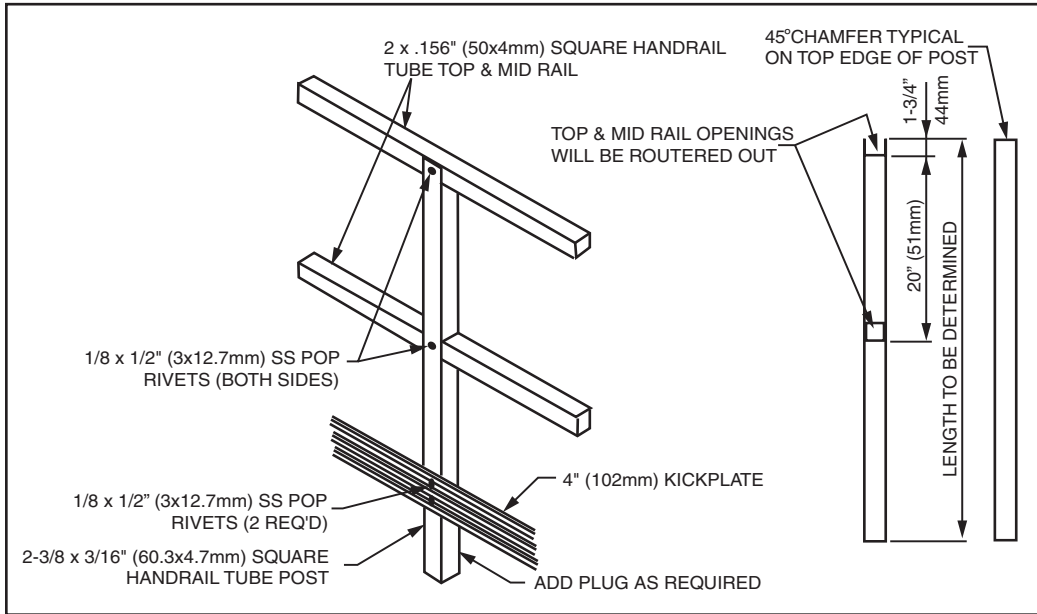

List of Components & Accessory Items

- 2" x 2" x .156" (50 x 50 x 4mm) Square Tube Yellow Polyester Fire Retardant, UV Inhibited @ 240" (6096mm)
- 2-3/8" x 2-3/8" x 3/16" (60.3 x 60.3 x 4.7mm) Square Tube Yellow, Polyester Fire Retardant, UV Inhibited @ 240" (6096mm)
- 4" Kickplate, Yellow, Polyester Fire Retardant, UV Inhibited @ 240" (6096mm)
- 6" Kickplate, Yellow, Polyester Fire Retardant, UV Inhibited @ 240" (6096mm)
- FRP Base Plate with Post — Total Height 40" (1016mm) (Polyester)
- 2-3/8" x 2-3/8" x 3/16" (60.3 x 60.3 x 4.7mm) Alternate Handrail Post, Routed Out, No Bottom Plugs
- Black End Caps
- Adjustable Corner Assembly (Total Assembly)
- 90° Corner Plug
- Kickplate Splice
- Kickplate 90° Splice
- Split Round Tube 8" (203.2mm) Length
- Split Round Tube 4" (101.6mm) Length
- Split Round Tube 144" (3657.6mm) Length
- 6" (152.4mm) Square Plug
- 144" (3657.6mm) Square Plug
- SS Rivets
- 1/8" x 1-1/2" (3x12.7mm) Tension Pins
- Epoxy Kits — 1 Pint Yellow
- Core Drill (1.68" [42.7mm] Dia.)
- 1/8" x 1/2" SS Pop Rivets
- 90° Corner Sample
- Tee Sample

TOOLS

- Electric Drill
- Hammer
- Core Drill and 1/8" (3.2mm) Drill Bits
- Circular Saw
- Sandpaper
- Circular Saw Blades

NOTE: Tungsten carbide-tipped core drill bit and 7" (177.8mm) grit-edged tungsten carbide circular saw blades are recommended (available from Chatfield Location).



STRONGWELL

ISO-9001 Quality Certified Manufacturing Plants

BRISTOL LOCATION

400 Commonwealth Ave., P. O. Box 580, Bristol, VA 24203-0580 USA
(276) 645-8000

CHATFIELD LOCATION

1610 Highway 52 South, Chatfield, MN 55923-9799 USA
(507) 867-3479