



STRONGWELL

AVAILABILITY LIST

EXTREN® Structural Shapes and Plate	2
Special Composite Shapes	4
DURADEK® Pultruded Grating	6
DURAGRATE® Molded Grating.....	8
DURATREAD™ Molded Stair Tread Covers	9
SAFRAIL™ Industrial Handrail Systems	9
CUSTOM Handrail Systems	10
Baffle Wall Panels	11
COMPOSOLITE® Building Panel System.....	11
DURASHIELD® Foam Core Building Panel System	11
DURASHIELD HC® Hollow Core Building Panel System	11
SAFPLANK® Interlocking Decking System	12
SAFDECK® Overlapping Decking System	12
STRONGDEK™ Architectural Decking System	12
FIBREBOLT® Studs and Nuts	12
HS ARMOR PANEL Ballistic Panel	13
General Information.....	14

EXTREN®

FIBERGLASS STRUCTURAL SHAPES & PLATE

EQUAL LEG ANGLES

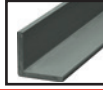

Sizes in inches	Series 500	Series 525	Series 625	lbs. per lin. ft.
1 x 1/8	STOCKED	STOCKED	STOCKED	0.18
1-1/4 x 1/8	NS	NS	NS	0.24
1-1/4 x 3/16	STOCKED	STOCKED	NS	0.35
1-1/2 x 1/8	NS	STOCKED	NS	0.29
1-1/2 x 3/16	NS	NS	NS	0.43
1-1/2 x 1/4	STOCKED	STOCKED	STOCKED	0.56
2 x 1/8	NS	NS	NS	0.40
2 x 3/16	STOCKED	STOCKED	NS	0.59
2 x 1/4	STOCKED	STOCKED	STOCKED	0.77
3 x 1/4	STOCKED	STOCKED	STOCKED	1.19
3 x 3/8	STOCKED	STOCKED	STOCKED	1.76
4 x 1/4	STOCKED	STOCKED	STOCKED	1.61
4 x 3/8	STOCKED	STOCKED	STOCKED	2.39
4 x 1/2	NS	STOCKED	STOCKED	3.15
5 x 1/2	NS	NS	NS	3.96
6 x 1/4	NS	STOCKED	NS	2.47
6 x 3/8	NS	STOCKED	NS	3.65
6 x 1/2	STOCKED	STOCKED	STOCKED	4.80

CHANNELS

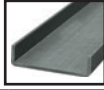

Sizes in inches	Series 500	Series 525	Series 625	lbs. per lin. ft.
1-1/2 x 1 x 3/16	NS	NS	NS	0.50
1-1/2 x 1-1/2 x 1/4	NS	STOCKED	NS	0.84
2 x 9/16 x 1/8	STOCKED	STOCKED	NS	0.29
2 x 7/8 x 1/4	NS	NS	NS	0.67
2-5/8 x 1/8 x 1-1/4 x 3/16	NS	NS	NS	0.63
3 x 7/8 x 1/4	STOCKED	STOCKED	STOCKED	0.84
3 x 1 x 3/16	NS	NS	NS	0.73
3 x 1-1/2 x 1/4	NS	NS	NS	1.10
3-1/2 x 1-1/2 x 3/16	NS	STOCKED	NS	0.93
4 x 1-1/16 x 1/8	NS	NS	NS	0.60
4 x 1-1/8 x 1/4	STOCKED	STOCKED	NS	1.16
4 x 1-3/8 x 3/16	STOCKED	STOCKED	STOCKED	0.97
5 x 1-3/8 x 1/4	NS	NS	NS	1.48
5-1/2 x 1-1/2 x 3/16	NS	STOCKED	NS	1.25
5-1/2 x 1-1/2 x 1/4	NS	STOCKED	NS	1.68
6 x 1-5/8 x 1/4	STOCKED	STOCKED	STOCKED	1.79
6 x 1-11/16 x 3/8	NS	STOCKED	NS	2.71
8 x 2-3/16 x 1/4	NS	STOCKED	NS	2.49
8 x 2-3/16 x 3/8	STOCKED	STOCKED	STOCKED	3.66
10 x 2-3/4 x 1/2	NS	STOCKED*	STOCKED*	6.09
12 x 3 x 1/2	NS	STOCKED*	STOCKED*	6.86
14 x 3-1/2 x 3/4	NS	NS	NS	12.28
18 x 2-3/16 x 3/16	NS	NS	NS	3.48
24 x 3 x 1/4	NS	NS	NS	6.38

I-BEAMS

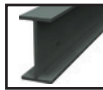

Sizes in inches	Series 500	Series 525	Series 625	lbs. per lin. ft.
2 x 1 x 1/8	NS	NS	NS	0.39
3 x 1-1/2 x 1/4	NS	NS	NS	1.16
4 x 2 x 1/4	STOCKED	STOCKED	STOCKED	1.59
5-1/2 x 2-1/2 x 1/4	NS	STOCKED	NS	2.08
6 x 3 x 1/4	NS	STOCKED	NS	2.42
6 x 3 x 3/8	NS	NS	NS	3.55
6 x 4 x 1/4	NS	NS	NS	2.76
8 x 4 x 3/8	STOCKED	STOCKED	NS	4.81
8 x 4 x 1/2	NS	NS	NS	6.31
10 x 5 x 3/8	NS	NS	NS	6.07
10 x 5 x 1/2	NS	STOCKED	NS	7.99
12 x 6 x 1/2	NS	STOCKED*	STOCKED*	9.67
18 x 3/8 x 4-1/2 x 1/2	NS	NS	NS	9.32
24 x 3/8 x 7-1/2 x 3/4	NS	STOCKED	NS	16.72

WIDE FLANGE BEAMS

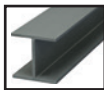

Sizes in inches	Series 500	Series 525	Series 625	lbs. per lin. ft.
2 x 1/8	NS	NS	NS	0.60
3 x 1/4	STOCKED	STOCKED	NS	1.79
4 x 1/4	STOCKED	STOCKED	STOCKED	2.43
6 x 1/4	STOCKED	STOCKED	STOCKED	3.69
6 x 3/8	STOCKED	STOCKED	STOCKED	5.44
8 x 3/8	NS	STOCKED	STOCKED	7.33
8 x 1/2	NS	STOCKED	STOCKED	9.67
10 x 3/8	NS	STOCKED +	STOCKED +	9.22
10 x 1/2	NS	NS	NS	12.22
12 x 1/2	NS	NS	NS	14.71

All items are stocked in 20 foot lengths unless otherwise noted
 * Stocked in 24 foot lengths. + Stocked in 32 foot lengths.
 NS Items are non-stocked items

Series 500 - Polyester resin, olive green
 Series 525 - Polyester resin, flame retardant, slate gray
 Series 625 - Vinyl Ester resin, flame retardant, beige

NOTE: Inventory of nonstocked items may be available due to overruns.

SQUARE TUBE

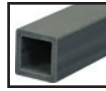

Sizes in inches	Series 500	Series 525	Series 625	lbs. per lin. ft.
1 x 1/8	STOCKED	STOCKED	NS	0.36
1-1/4 x 1/8	NS	NS	NS	0.47
1-1/2 x 1/8	STOCKED	STOCKED	NS	0.57
1-1/2 x 1/4	NS	NS	NS	1.04
1-3/4 x 1/8	NS	NS	NS	0.68
1-3/4 x 1/4	NS	NS	NS	1.25
2 x 1/8	NS	STOCKED	NS	0.78
2 x 1/4 ‡	STOCKED	STOCKED	STOCKED	1.46
2-1/2 x 1/4	NS	NS	NS	1.89
3 x 1/8	NS	NS	NS	1.20
3 x 1/4	STOCKED	STOCKED	STOCKED	2.30
3 x 3/8	NS	NS	NS	3.28
3-1/2 x 1/4	NS	STOCKED	STOCKED	2.73
4 x 1/4	STOCKED	STOCKED	STOCKED	3.14
4 x 3/8	NS	NS	NS	4.60
6 x 3/8	NS	STOCKED	NS	6.85

ROUND TUBE



Sizes in inches	Series 500	Series 525	Series 625	lbs. per lin. ft.
1 x 1/8	NS	NS	NS	0.29
1-1/4 x 1/8	NS	NS	NS	0.37
1-1/2 x 1/8	NS	NS	NS	0.45
1-1/2 x 1/4	NS	NS	NS	0.82
1-3/4 x 1/8	NS	NS	NS	0.54
1-3/4 x 1/4	NS	NS	NS	0.99
2 x 1/8	NS	NS	NS	0.62
2 x 1/4	STOCKED	STOCKED	NS	1.15
2-1/2 x 1/4	STOCKED	STOCKED	NS	1.49
3 x 1/4	NS	NS	NS	1.81
3-1/2 x .140	NS	NS	NS	1.24
4 x 1/4	NS	NS	NS	2.47
5 x 1/4	NS	NS	NS	3.13
6 x 1/8	NS	NS	NS	1.94
6 x 1/4	NS	NS	NS	3.80

RECTANGULAR TUBE

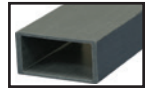

Sizes in inches	Series 500	Series 525	Series 625	lbs. per lin. ft.
2-1/2 x 1-5/8 x 1/8	NS	NS	NS	0.81
4 x 1/8 x 2 x 1/4	STOCKED	STOCKED	NS	1.58
3-1/2 x 5-1/2 x 1/4	NS	STOCKED	NS	3.48
6-1/2 x 1/4 x 2 x 1/2	NS	NS	NS	3.99
7 x 4 x 1/4	NS	NS	NS	4.41
9 x 6 x 5/16	NS	NS	NS	7.36
9 x 6 x 7/16	NS	NS	NS	10.16

PLATE

EXTREN® pultruded plate is stocked in six thicknesses - see below.

EXTREN® plate is a stocked item and is usually available on short notice. Stock size is 48" x 96".

60" wide plate is also available, non-stocked. Other sizes are available and will be quoted upon request.

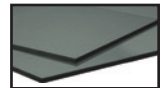

Thickness in inches	Series 500	Series 525	Series 625	Weight lbs. per sq. ft
1/8	STOCKED	STOCKED	STOCKED	1.26
3/16	STOCKED	NS	NS	1.89
1/4	STOCKED	STOCKED	STOCKED	2.52
3/8	STOCKED	STOCKED	NS	3.78
1/2	STOCKED	STOCKED	STOCKED	5.04
5/8	NS	NS	NS	6.30
3/4	STOCKED	STOCKED	STOCKED	7.56
1	NS	STOCKED	STOCKED	10.08

All items are stocked in 20 foot lengths unless otherwise noted

‡ Also stocked in Series 525 yellow

■ Items are non-stocked items

Series 500 - Polyester resin, olive green

Series 525 - Polyester resin, flame retardant, slate gray

Series 625 - Vinyl Ester resin, flame retardant, beige

NOTE: Inventory of nonstocked items may be available due to overruns.

ROD AND BAR

THERMAL CURE ROD AND BAR is produced using all longitudinal reinforcements with low speed and high temperature, which provides a rich surface appearance. It has no surfacing veil, no pigment and is not fire retardant. On request, Strongwell can quote special formulations including resin type, fire retardant properties, etc. Because it maintains high electrical standards, thermal cure rod is most commonly specified for electrical applications. Normally stocked for prompt delivery. *Thermal cure rod and bar was not designed to be machined.*

ROUND ROD*

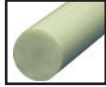

SQUARE BAR*

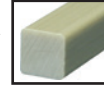

Sizes in inches	Thermal Cure	lbs. per lin. ft.
1/4	STOCKED	0.04
5/16	STOCKED	0.07
3/8	STOCKED	0.10
1/2	STOCKED	0.17
5/8	STOCKED	0.27
3/4	STOCKED	0.39
13/16	NS	0.45
7/8	NS	0.53
1	STOCKED	0.69
1-1/8	NS	0.87
1-1/4	NS	1.03
1-1/2	STOCKED	1.52
2	NS	2.78

Sizes in inches	Thermal Cure	lbs. per lin. ft.
1/2	STOCKED	0.22
5/8	STOCKED	0.34
3/4	NS	0.49
1	STOCKED	0.87
1-1/4	NS	1.35
1-1/2	STOCKED	1.83





Sizes 3/4" diameter and smaller will be stocked in Chatfield, MN

SPECIAL COMPOSITE SHAPES

(Special Composite Design — Not EXTREN® Composite)

All Special Composite Shapes are Nonstocked items unless otherwise noted.

Tooling is available for the following special nonstocked items

	PE	PE/FR	VE/FR	lbs. per lin. ft.
TOP RAIL 				
2 x 1/4 Modified Rd Tube	NS	NS	NS	1.29
FLIGHT CHANNEL 				
5-1/4 x 1/8 x 2-1/2 x 3/16	NS			1.33
7-1/8 x 1/8 x 2-1/2 x 3/16	NS			1.60
CHANNEL 				
3-1/2 x 2 x 7/32	NS	STOCKED	NS	1.20
1.875 x .125 x 1.125 x .188**	NS			0.48
3.290 x .128 x 1.180 x .190**	NS			0.65
3.310 x .135 x 1.187 x .210**	NS			0.69
4.000 x .125 x 1.750 x .187**	NS			0.94
STRUT 				
1-5/8 x 1-5/8 x 5/32	NS	NS	NS	0.65
SQUARE TUBE/ROUND HOLE 				
1" Sq. with 3/4" Rd. Hole	NS	NS	NS	0.49







All items are stocked in 20 foot lengths unless otherwise noted
 Items are non-stocked items

* Special Composite Design - Not EXTREN® Composite
 ** Nonstocked item; standard color - orange

SPECIAL COMPOSITE SHAPES

(Special Composite Design — Not EXTREN® Composite)

Tooling is available for the following special nonstocked items

	PE	PE/FR	VE/FR	lbs. per lin. ft.
SLIDE GUIDE 				
2-1/2 x 2-1/4 x 1/4	NS			1.24
ANGLE 				
1-3/4 x 1-1/4 x 1/4	NS	NS	NS	0.51
10-1/2 x 10-1/2 x 1	NS	NS	NS	16.00
FLAT STRIP 				
2 x 3/16*	NS	STOCKED	STOCKED	0.32
2 x 1/4	NS	NS	NS	0.39
3 x 3/16	NS	NS	NS	0.41
3 x 1/4	NS	STOCKED	NS	0.59
3 x 3/8	NS	NS	NS	0.88
3 x 1/2	NS	STOCKED	NS	1.12
3-1/2 x 1/2	NS	NS	NS	1.31
4 x 1/2	NS	NS	NS	1.49
6 x 1/8	NS	NS	NS	0.57
6 x 1/4	NS	NS	NS	1.24
FLUTED TUBE 				
1-1/4**			STOCKED	0.40
F-SECTION 				
5-1/2 x 1 x 1/4***	NS	NS	NS	1.58
6 x 1-1/2 x 1/4	NS	NS	NS	1.69
Z-SECTION 				
1-1/4 x 2-1/2 x 1/8	NS	NS	NS	0.48
CORNER POST 				
3-1/4 X 1/4	NS	NS	NS	2.35

All items are stocked in 20 foot lengths unless otherwise noted

 Items are non-stocked items

* Stocked item in yellow in 24' lengths

** Stocked item in yellow in 242" lengths

*** Stocked in Chatfield, MN

DURA DEK[®]

PULTRUDED FIBERGLASS GRATING

STOCKING LEVELS OF GRATING MAY VARY. CALL FOR AVAILABILITY.

STANDARD SIZE PANELS

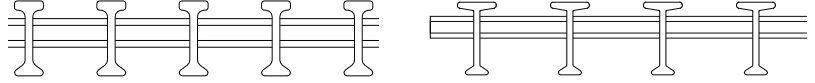

Panel Size (Width x Length)	PE I-6500 - 1" VE I-6500 - 1"	PE I-6500 - 1-1/2" VE I-6500 - 1-1/2"	PE T-5800 - 2" VE T-5800 - 2"
	wt. (lbs.)	wt. (lbs.)	wt. (lbs.)
3' x 10'	66	81	—
3' x 20'	132	162	156
4' x 8'	70.4	86.4	—
4' x 12'	105.6	129.6	124.8
4' x 20'	176	216	208
5' x 10'	110	135	135
5' x 20'	220	270	260

Colors:	Yellow or Gray	UV Protection:	UV Inhibited with a Veil
Resins:	Fire Retardant Polyester - Standard	Top Surface:	Epoxy Bonded Grit Coating
	Fire Retardant Vinyl Ester - Optional	Cross Rods:	8" o.c.

DURA DEK®

PULTRUDED FIBERGLASS GRATING

ACCESSORY ITEMS

ALL ITEMS GENERALLY ARE IN INVENTORY FOR IMMEDIATE SHIPMENT

PANEL HOLD DOWNS

(Price Does Not Include Nuts, Bolts & Washers)

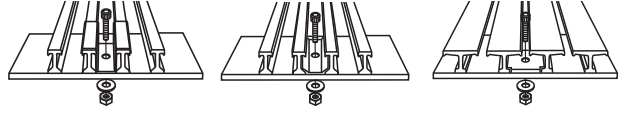

(No Broken Packages)

lbs. approx.
(25 per Package)

S.S. Insert Hold Down, all series (Specify I-6500 or T-5800)	1.00
S.S. Saddle Clip Only, I-6500 - 1"	2.00
S.S. Saddle Clip Only, I-6500 - 1-1/2"	2.25
S.S. Saddle Clip Only, T-5800 - 2"	3.25
1/4" - 20 x 1-1/4" S.S. Socket Head Cap Screw with Nut & Washer (For use with Hold Downs)	0.75

PANEL CONNECTORS ASSEMBLY

(Assembly includes Hold Down(s), Bolt(s) and Bottom Bar)

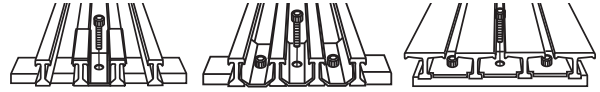

lbs.
approx.

S.S. Insert Panel Connector, all series	0.40
S.S. Saddle Clip Panel Connector, I-6500 - 1"	0.29
S.S. Saddle Clip Panel Connector, I-6500 - 1-1/2"	0.30
S.S. Saddle Clip Panel Connector, T-5800 - 2"	0.30

FIBERGLASS CURB ANGLE

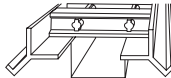

lbs. approx.
per lin. ft.

1" x 1-1/2"	STOCKED	0.83
1-1/2" x 1-1/2"	STOCKED	0.93
2" x 1-1/2"	STOCKED	1.03
4" x 2-1/4" x 1/4" (Slate Gray)	NS	5.33

Color: Gray	UV Inhibited with a Veil
Resin: Fire Retardant, Vinyl Ester	Stock Length: 20 feet

MISCELLANEOUS

lbs.
approx.

Sealing Kit - 1 pint	1.64
7" Tungston Carbide Tip Circular Blade	0.64
Tungston Carbide Tip Saber Saw Blade	0.03

DURA GRATE®

MOLDED FIBERGLASS GRATING

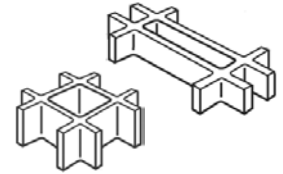

STOCKING LEVELS OF GRATING MAY VARY. CALL FOR PRICING, COLOR OPTIONS AND AVAILABILITY.

RESINS OPTIONS:

GP — GENERAL POLYESTER RESIN SYSTEM
PP — PREMIUM POLYESTER RESIN SYSTEM

VE — VINYL ESTER RESIN SYSTEM
FF — FOOD GRADE RESIN SYSTEM

Thickness	Mesh	Panel Size	Estimated Weight (lbs.)
1"	1" x 4"	3' x 10'	84
1"	1" x 4"	4' x 8'	90
1"	1" x 4"	4' x 12'	135
1"	1-1/2" x 1-1/2"	3' x 10'	78
1"	1-1/2" x 1-1/2"	4' x 8'	83
1"	1-1/2" x 1-1/2"	4' x 12'	125
1-1/2"	1-1/2" x 1-1/2"	3' x 10'	114
1-1/2"	1-1/2" x 1-1/2"	4' x 8'	122
1-1/2"	1-1/2" x 1-1/2"	4' x 12'	183
2"	2" x 2"	4' x 12'	192

STAIR TREAD*

1-1/2"	1-1/2" x 6"	22-1/2" x 10'	60
--------	-------------	---------------	----

*NOTE: Nosing is gritted and same color as stair tread.

• Other resins, colors and accessories available on special orders. Call factory for details.

ACCESSORY ITEMS

Item

(No Broken Packages)

Type M Clip for 1" x 1" x 4" Rectangular Mesh ② or ③

Type M Clip for 1" x 1-1/2" Square Mesh ② or ③

Type M Clip for 1-1/2" x 1-1/2" Square Mesh ⑤

Type M Clip Deep for 1-1/2" x 1-1/2" Square Mesh or 1-1/2" x 6" Rectangular Mesh ④

Type M Clip for 2" x 2" Square Mesh ⑥

Type J Clip for 1" ①

Type J Clip for 1-1/2" ①

Type J Clip for 2" ①

Type C Clip Assembly for 1"

Type C Clip Assembly for 1-1/2"

Type C Clip Assembly for 2"

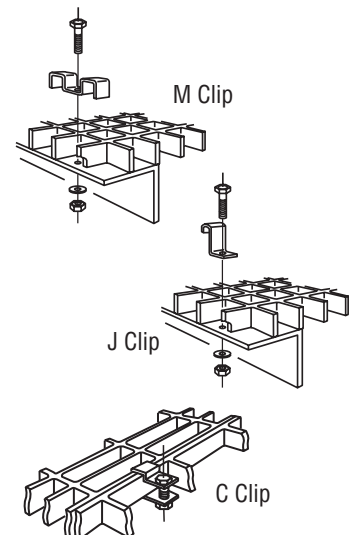

(ALL CLIPS AND BOLTS S.S. 316)

Typical bolts to use for Clips:

① 1/4" x 1" Hex Head Cap Screw with Nut and Washer

② 1/4" x 1-1/2" Hex Head Cap Screw with Nut and Washer

③ 1/4" x 1-3/4" Hex Head Cap Screw with Nut and Washer

④ 1/4" x 1-1/4" Socket Head Cap Screw with Nut and Washer

⑤ 1/4" x 2" Hex Head Cap Screw with Nut and Washer

⑥ 1/4" x 2-1/2" Hex Head Cap Screw with Nut and Washer

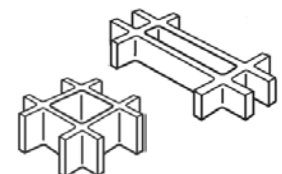

DURATREAD™

MOLDED FIBERGLASS STAIR TREAD COVERS

STOCKING LEVELS MAY VARY. CALL FOR PRICING, COLOR OPTIONS AND AVAILABILITY.

RESINS OPTIONS:

GP — GENERAL POLYESTER RESIN SYSTEM VE — VINYL ESTER RESIN SYSTEM
 PP — PREMIUM POLYESTER RESIN SYSTEM FF — FOOD GRADE RESIN SYSTEM

Tread (inches)	Thickness 1/8" Weight (lbs.)	Thickness 1/4" Weight (lbs.)
8	16	31
9	18	34
10	19	37
11	21	40
12	23	44

**All covers are 12' long. • No minimum on black with yellow nose covers. • The minimum order quantity for all other colors is 5 pieces.*

SAF RAIL™

FIBERGLASS HANDRAIL SYSTEMS

ALL ITEMS GENERALLY ARE IN INVENTORY FOR IMMEDIATE SHIPMENT

SQUARE HANDRAIL SYSTEM COMPONENTS

Component	Weight (lbs.)
2" x 2" x .156" Square Tube, Yellow Polyester Fire Retardant UV Inhibited @ 240"	0.95 / ft.
2-3/8" x 2-3/8" x 3/16" Square Tube, Yellow Polyester Fire Retardant UV Inhibited @ 240"	1.36 / ft.
4" Kickplate Yellow Polyester Fire Retardant UV Inhibited @ 240"	0.65 / ft.
6" Kickplate Yellow Polyester Fire Retardant UV Inhibited @ 240" (1,200 ft. mill run)	0.73 / ft.
Black End Caps	0.03 ea.
Adjustable Corner Assembly (Total Assembly)	0.36 ea.
90° Corner Plug	0.35 ea.
Kickplate Splice	0.11 ea.
Kickplate 90° Splice	0.15 ea.
Split Tube 8" Length (for square handrail)	0.35 ea.
Split Tube 4" Length (for square handrail)	0.18 ea.
Split Tube 144" Length (for square handrail)	6.12 ea.
6" Square Plug	0.76 ea.
Square Plug 144" Length	18.24 ea.
1/8" x 1-1/2" Tension Pins	.04 / 10 pcs.
Epoxy Kits - 1 Pint Clear	1.64 ea.
FRP Base Plate with Post - Total Height 40" (Polyester)	5.50 ea.
Alternate Handrail Post, 2-3/8" x 2-3/8" x 50", Routed Out, No Bottom Plugs	5.70 ea.
90° Corner Sample	1.30 ea.
Tee Sample	0.90 ea.

NOTE: UV Coating is recommended for exterior applications and is available at an additional cost.

SAFRAIL™

FIBERGLASS HANDRAIL SYSTEMS

ALL ITEMS GENERALLY ARE IN INVENTORY FOR IMMEDIATE SHIPMENT



ROUND HANDRAIL SYSTEM COMPONENTS

Component	Weight (lbs.)
1.9" OD x 1.5" ID Yellow Polyester Fire Retardant UV Inhibited	0.88 / ft.
4" Kickplate Yellow Polyester Fire Retardant UV Inhibited @ 240"	0.65 / ft.
Black End Caps	0.05 ea.
Adjustable Corner Assembly (Total Assembly)	0.36 ea.
90° Corner Assembly	0.35 ea.
Intermediate Connectors	0.05 ea.
Kickplate Splice	0.11 ea.
Kickplate 90° Splice	0.15 ea.
Split Tube, 1.5 x 4" (for round handrail)	0.15 ea.
Split Tube, 1.5 x 8" (for round handrail)	0.30 ea.
Round Connector, 1.5 x 8"	0.53 ea.
1/8" x 1-1/2" Tension Pins	0.04 / 10 pcs.
FRP Base Plate with Post, Total Height 39-9/16" (YFRPE)	5.50 / pc.
Stainless Steel Kickplate Bracket	0.12 ea.
1/4" x 1" Stainless Steel Bolt Assembly	.05 ea.

CHANNEL TOP HANDRAIL SYSTEM COMPONENTS

For more information on the Channel Top option, please refer to the SAFRAIL™ brochure.

Component	
1" Diameter Mid Rail, Yellow Polyester Fire Retardant, UV Coated	(5,000 linear feet min. run)
Channel Top Handrail, Yellow Polyester Fire Retardant, UV Coated	(5,000 linear feet min. run)
2" x 2" x .156" Tube (for post), Yellow Polyester Fire Retardant, UV Coated	
4" Kick Plate, Yellow Polyester Fire Retardant, UV Coated	



CUSTOM FIBERGLASS HANDRAIL SYSTEMS

CUSTOM FABRICATED HANDRAIL

Handrail may be ordered in custom colors and/or resins and may also be pre-fabricated. Prices and ship dates for custom fabricated handrail may be obtained by calling Strongwell Customer Service.

NOTE: UV Coating is recommended for exterior applications and is available at an additional cost.

FIBERGLASS BAFFLE WALL PANELS

PANELS

Width in inches	PE	lbs. per lin. ft.
12"	NS	3.70
24*	NS	6.50

COMPOSOLITE® FIBERGLASS BUILDING PANEL SYSTEM

PANEL SYSTEM COMPONENTS

Components	PE	PE/FR	VE/FR	lbs. per lin. ft.
Panel**	NS	STOCKED	NS	7.52
Toggle	NS	STOCKED	NS	0.33
3-Way Connector	NS	STOCKED	NS	1.70
Hangar	NS	NS	NS	1.55
45° Connector	NS	NS	NS	1.75
3.42" x 1.3" x .125" Cap Channel ***	NS	STOCKED	NS	0.60
3.665" x 2" x 1/4" Structural Cap Channel	NS	NS	NS	1.30

DURASHIELD® FIBERGLASS FOAM CORE BUILDING PANEL SYSTEM

PANELS

Thickness in inches	PE	PE/FR	VE/FR	lbs. per lin. ft.
1"	NS	NS	NS	2.20
3"	NS	NS	NS	7.85

DURASHIELD HC® FIBERGLASS HOLLOW CORE BUILDING PANEL SYSTEM

PANELS

Thickness in inches	PE	PE/FR	VE/FR	lbs. per lin. ft.
1"	NS	NS	NS	3.27

* Stocked in 24' length

** Stocked in 20' and 24' lengths

*** Also stocked in series 525 yellow, 20' lengths

FIBERGLASS DECKING PRODUCTS

SAFPLANK®

FIBERGLASS INTERLOCKING DECKING SYSTEM

SAFDECK®

FIBERGLASS OVERLAPPING DECKING SYSTEM

STRONGDEK™

FIBERGLASS ARCHITECTURAL DECKING SYSTEM

DECKING PANELS

Panel	PE	PE/FR	VE/FR	lbs. per lin. ft.
12" SAFPLANK® *	NS	STOCKED	NS	2.50
24" SAFPLANK® *	NS	STOCKED	NS	5.00
36" SAFPLANK HD® **	NS	STOCKED	NS	21.00
SAFDECK® **	NS	STOCKED	NS	3.75
STRONGDEK™ **	NS	NS	NS	2.58

* Stocked in 20' and 24' lengths

** Stocked in 24' lengths

DECKING ACCESSORIES

Sizes in inches	PE	PE/FR	VE/FR	lbs. per lin. ft.
2.2 x 1.063 x .563 x .080 Cap Channel	NS	NS	NS	0.24
STRONGDEK™ Starter Channel	NS	NS	NS	

FIBRE BOLT®

FIBERGLASS STUDS AND NUTS

STUDS

Sizes in inches	Studs Per Package	Package Weight (lbs.)
3/8	15	4.5
1/2	10	5.0
5/8	10	7.5
3/4	6	7.0
1	4	8.5

HEX NUTS

Sizes in inches	Nuts Per Package	Package Weight (lbs.)
3/8	100	1.5
1/2	100	2.0
5/8	100	3.8
3/4	25	3.0
1	25	3.0

HS ARMOR PANELS

FIBERGLASS BALLISTIC PANEL

UL LEVEL 1 (OFF WHITE)

Panel		lbs. per lin. ft.
1/4" x 36" x 96"	STOCKED	8.14
1/4" x 48" x 96"	STOCKED	11.00
1/4" x 36" x 120"	STOCKED	8.14
1/4" x 48" x 120"	STOCKED	11.00

UL LEVEL 2 (OFF WHITE)

Panel		lbs. per lin. ft.
.35" x 36" x 96"	STOCKED	11.06
.35" x 48" x 96"	STOCKED	14.32
.35" x 36" x 120"	STOCKED	11.06
.35" x 48" x 120"	STOCKED	14.32

UL LEVEL 3 (OFF WHITE)

Panel		lbs. per lin. ft.
1/2" x 36" x 96" - Color: Off-white	STOCKED	15.70
1/2" x 48" x 96" - Color: Off-white	STOCKED	21.70
1/2" x 36" x 120" - Color: Off-white	STOCKED	15.70
1/2" x 48" x 120" - Color: Off-white	STOCKED	21.70

GENERAL INFORMATION

EXTREN® SERIES 500

An all-purpose series utilizing a premium polyester resin system with a UV inhibitor.

Color: olive green

EXTREN® SERIES 525

An all-purpose series utilizing a fire retardant premium polyester resin system with a UV inhibitor.

Color: slate gray (plus certain handrail and fixed ladder components in yellow)

EXTREN® SERIES 625

A premium series — both fire retardant and highly corrosion resistant — utilizing a vinyl ester resin system with a UV inhibitor.

Color: beige

Note 1: Any Series 500, 525 and 625 EXTREN® product can be manufactured upon request to meet the mechanical and physical properties of BS EN 13706 (E23) European standards (minimum quantities may apply). All standard EXTREN® products meet and/or exceed the structural requirements of E17 European standards.

Note 2: All EXTREN® Series 500 products can be produced to meet NSF potable water standards. Minimum quantities may apply. Only products bearing the NSF logo are certified.

STOCKED ITEMS

Carried in inventory, no minimum quantity required.

LENGTHS CUT FROM STOCK: Special lengths can be cut from stock shapes and rods. Plate can be cut to size desired from 48" x 96" stock. A fabrication cutting charge will be applied.

NONSTOCKED ITEMS

Tooling available. Check for possible availability.

SMALL QUANTITIES OF NONSTOCKED ITEMS: These are occasionally available because of overruns. Purchaser having a requirement for small quantities of nonstocked items should inquire about current inventory status. Such items are subject to prior sale, so delivery cannot be guaranteed.

MILL RUN

SPECIAL MILL RUN VARIANCE: The pultrusion process does not lend itself to producing exact quantities. Mill runs may vary 10% on small orders, and as much as 3-5% on large orders. If minimum quantities are required, orders should be placed considering these variances.

MINIMUM ORDER VALUE

Minimum order value is \$250.

COLORS

Special colors are available for shapes and plate. Extra cost will vary, depending on cost, amount of pigment required, and standards of acceptability. Minimum quantities may apply.

SPECIAL RESINS AND FORMULAE

Special resins and resin mixes will be quoted specifically after resin mix has been tested for adaptability to the production process involved.

PACKAGING

If other than standard packaging is required, contact Customer Service for additional costs.

TERMS

All products are manufactured in accordance to tolerance properties as published in Strongwell's *Design Manual*. Strongwell's Standard Terms and Condition of Sale apply. F.O.B./Ex Works dispatch location.



ISO-9001 Quality Certified Manufacturing Plants



BRISTOL LOCATION

400 Commonwealth Ave., P. O. Box 580
Bristol, VA 24203-0580 USA
(276) 645-8000

CHATFIELD LOCATION

1610 Highway 52 South
Chatfield, MN 55923-9799 USA
(507) 867-3479
www.strongwell.com

HIGHLANDS LOCATION

26770 Newbanks Road
Abingdon, VA 24210 USA
(276) 645-8000