

SECTION 5

TOLERANCES



Look for this blue line in the left margin of the Design Manual documents. This line shows you where the latest update has been made.

TOLERANCES

INTRODUCTION

Strongwell utilizes ASTM D3917, *Dimensional Tolerance of Thermosetting Glass-Reinforced Plastic Pultruded Shapes*, for a definition of the dimensions to be toleranced for **EXTREN**[®]. Confusion can easily exist when the terms being discussed are only loosely defined. For example, ASTM D3917 makes a clear distinction between straightness, camber and flatness. Strongwell will work with the customer to define the particular dimensional requirements.

For reference, classifying **EXTREN**[®] per ASTM D3647, *Classifying Reinforced Plastic Pultruded Shapes According to Composition*, yields the following:

EXTREN[®] Series 500/525 = GCPF

EXTREN[®] Series 600/625 = GCVF

INSPECTION

Strongwell verifies the adherence to dimensional tolerances in accordance with ASTM D3917 and visual standards in accordance with ASTM D4385 for the initial part from all **EXTREN**[®] production runs. At Strongwell, this initial sample is known as the First Article. The Modulus of Elasticity is also verified by a simple beam deflection test which is performed on the production floor.

Strongwell's production operators are an integral part of the Strongwell Quality Assurance program. The operators have been trained to inspect the product as it is produced with the quality assurance inspectors functioning as auditors and trainers.

TOLERANCES

The tolerances presented govern **EXTREN**[®] structural shapes and may not be arbitrarily applied to other pultruded profiles. Strongwell maintains an extremely active custom pultrusion business and these profiles place different demands on the composite design and dimensional tolerance. For example, **EXTREN**[®] structural shapes are balanced composites while custom composites, because of their special application, are not necessarily geometrically balanced.

In the tolerance section, some mathematical symbols will be used. These symbols are defined below:

- > "greater than" with the tip of the arrow pointing to the smaller number. For example, if it is stated that " $b > 2$ ", this means that dimension "b" is greater than "2". Conversely, " $b < 2$ " states that dimension "b" is less than "2".
- ≥ "greater than or equal to" with the tip of the arrow still pointing towards the smaller number. However, " $b \geq 2$ " now is interpreted as "b" is greater than or equal to "2".

NOTE:

Standard tolerances will be assumed as the target specifications for custom shapes in the absence of any customer supplied specifications.

Strongwell straightness tolerances are based on straightness as defined in this section. Camber is a special custom requirement (also defined in this section for plate).

**STANDARD TOLERANCES
OPEN SHAPES**

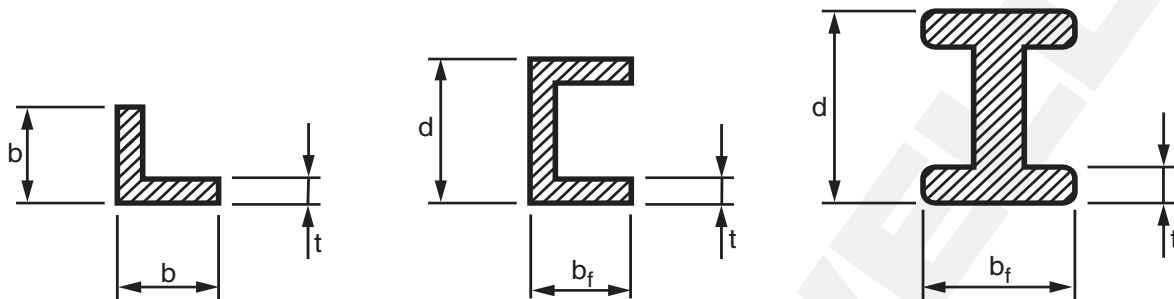

SHAPE	DIMENSION	TOLERANCE (% of nominal)	MAXIMUM OR MINIMUM TOLERANCES
ANGLES	t = thickness	-10%	- 0.010" minimum ①
	b = flange width	± 4%	± 0.094" maximum ②
CHANNELS	t = thickness	-10%	- 0.010" minimum ①
	b _f = flange width	± 4%	± 0.094" maximum ②
	d = depth	± 4%	± 0.094" maximum
W AND I-SHAPES	t = thickness	-10%	-0.010" minimum ①
	b _f = flange width	± 4%	±0.094" maximum ②
	d = depth	± 4%	±0.094" maximum

NOTES:

- ① For example, a 1/8" thickness would have a tolerance minimum of 0.125" - 10% = 0.112". An angle with a flange thickness of 0.090" would have a tolerance of 0.090" - 0.010" that is, a minimum tolerance of 0.080".
- ② Regardless of the flange width, a tolerance of no greater than ± 0.094" is permitted. This maximum tolerance is to be used when 4% of "b" or "b_f" exceeds 3/32".

**STANDARD TOLERANCES
OPEN SHAPES**

STRAIGHTNESS

As per ASTM D3917, straightness is the upward deviation of the structural shape when resting on a flat surface in such a manner that the weight of the pultruded shape minimizes the deviation.

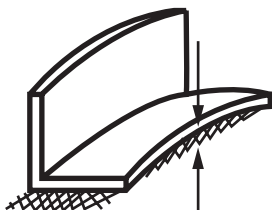

LENGTH	ALLOWABLE DEVIATION (in)
All	length in feet x 0.050"*

*Tested on a minimum length of 16 feet or the run length.

NOTE: Strongwell straightness tolerances are based on straightness as defined above. Camber, as defined in this section, is a special custom requirement.

TWIST

As per ASTM D3917 and ASTM D3918, twist describes the condition of a progressive rotation in the structural shape and is measured in such a manner that the weight of the pultruded shape minimizes the twist.

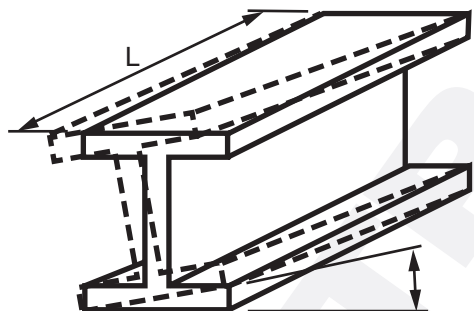

LARGEST DIMENSION- WIDTH OR DEPTH	ALLOWABLE TWIST
1.5" or less	1° times length in feet
1.5" to 2.99"	0.5° times length in feet
3" and over	0.5° times length in feet

**STANDARD TOLERANCES
OPEN SHAPES**

ANGULARITY

As per ASTM D3917, angularity is the adherence of the angles in the pultruded shape to a specified value.

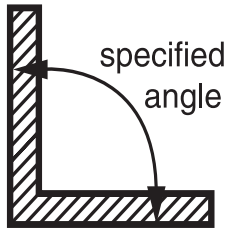

SPECIFIED ANGLE	TOLERANCE
All	$\pm 2^\circ$

FLATNESS (FLAT SURFACES)

As per ASTM D3917, flatness is the deviation from straight across the width of the dimension. Flatness can be contrasted with straightness, which specifies deviations along the length of the part.

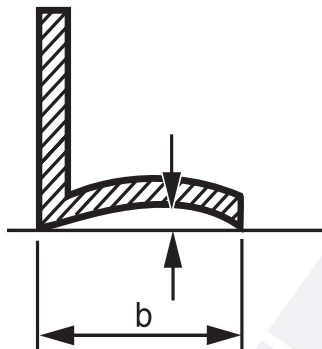

WIDTH (b)	TOLERANCE
All	0.008" per inch of width 0.008" minimum

**STANDARD TOLERANCES
TUBES**

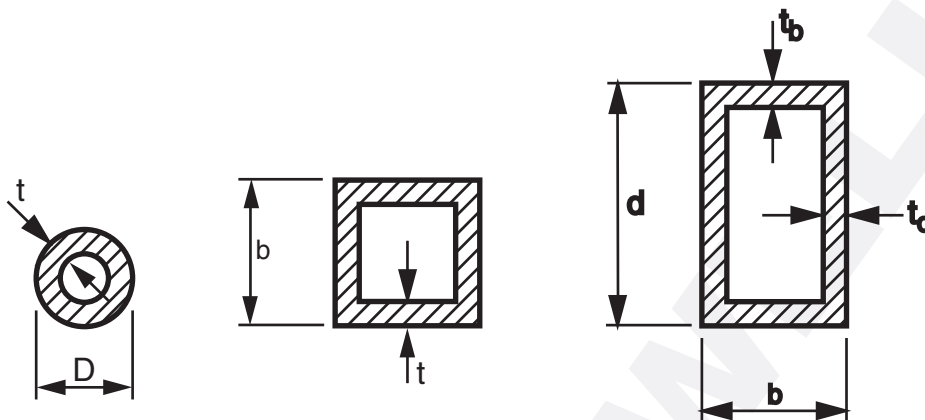

SHAPE	DIMENSION	TOLERANCE	OUTSIDE DIMENSION CONDITIONS
ROUND TUBE	t = thickness	- 20%	D ≤ 2"
		- 15%	D > 2"
	D = outside diameter	± 0.020"	D ≤ 2"
		± 1%	2" < D ≤ 4"
	± 1.5%	D > 4"	
SQUARE TUBE	t = thickness	- 20%	b ≤ 2"
		- 15%	b > 2"
	b = outside dimension	± 0.020"	b ≤ 2"
		± 1%	2" < b ≤ 4"
	± 1.5%	b > 4"	
RECTANGULAR TUBE	t _b or t _d = thickness	- 20%	b ≤ 2"
		- 15%	b > 2"
	d or b = outside dimension	± 0.020"	(d or b) ≤ 2"
		± 1%	2" < (d or b) ≤ 4"
	± 1.5%	(d or b) > 4"	

NOTE:

Tolerances of 1-3/4" x 1/8" and 1-3/4" x 1/4" vary from standard to provide telescoping of these sections.

**STANDARD TOLERANCES
TUBES**

STRAIGHTNESS

As per ASTM D3917, straightness is the upward deviation of the pultruded shape when resting on a flat surface in such a manner that the weight of the pultrusion minimizes the deviation.

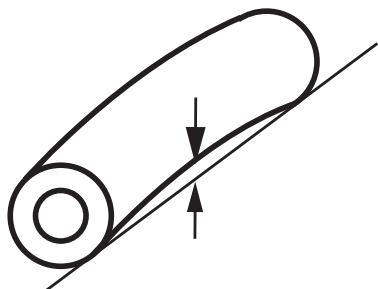

SPECIFIED OUTSIDE DIMENSION	ALLOWABLE DEVIATION (in)
2" or less	0.020" per foot of length
> 2"	0.030" per foot of length

NOTE: Strongwell straightness tolerances are based on straightness as defined above. Camber, as defined in this section, is a special custom requirement.

TWIST

As per ASTM D3917 and ASTM D3918, twist describes the condition of a progressive rotation in the pultruded shape and is measured in such a manner that the weight of the pultruded shape minimizes the deviation.

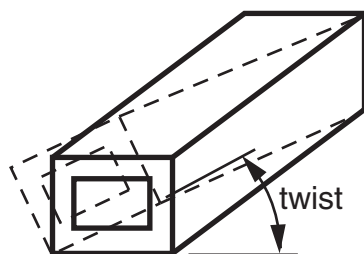

LARGEST OUTSIDE DIMENSION	ALLOWABLE TWIST	MAXIMUM TWIST
1.5" or less	1° per foot of length	7°
> 1-1/2"	1/2° per foot of length	5°

ANGULARITY

As per ASTM D3917, angularity is the adherence of the angles in the pultruded shape to a specified value.

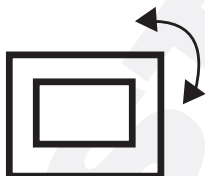

SPECIFIED ANGLE	TOLERANCE
All	2°

FLATNESS (FLAT SURFACES)

As per ASTM D3917, flatness is the deviation from straightness across the width of the dimension. Flatness can be contrasted with straightness which specifies deviations along the length of the part.

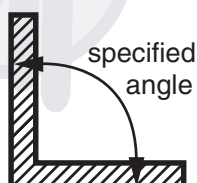

WIDTH (b)	TOLERANCE
All	0.008" per inch of outside dimension 0.008" minimum

**STANDARD TOLERANCES
ROUND AND SQUARE BAR**



SHAPE	DIMENSION	TOLERANCE	CONSTRAINTS
ROUND ROD	outside diameter (D)	± 0.020"	D < 3"
SQUARE BAR	outside diameter (b)	± 0.020"	b < 3"

STRAIGHTNESS

As per ASTM D3917, straightness is the upward deviation of a pultruded shape when resting on a flat surface in such a manner that the weight of the pultrusion (or pultruded shape) minimizes the deviation.

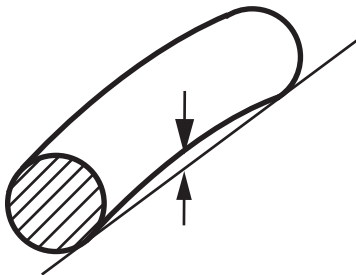

OUTSIDE DIMENSION	TOLERANCE (in)
≤ 1"	0.020" per foot of length
> 1"	0.030" per foot of length

NOTE: Strongwell straightness tolerances are based on straightness as defined above. Camber, as defined in this section, is a special custom requirement.

TWIST (BAR ONLY)

As per ASTM D3917, and ASTM D3918, twist describes a condition of a progressive rotation on the pultruded shape and is measured in such a manner that the weight of the pultruded shape minimizes the deviation.

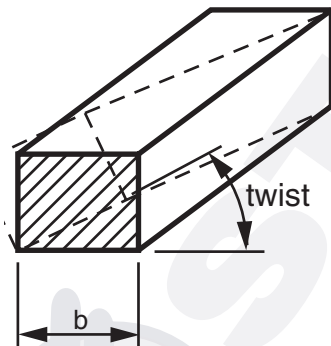

LARGEST OUTSIDE DIMENSION	ALLOWABLE TWIST
b ≤ 1"	1° per foot of length
b > 1"	0.5° per foot of length

FLATNESS (FLAT SURFACES)

As per ASTM D3917, flatness is the deviation from straight across the width of the part.

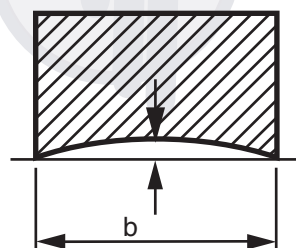

WIDTH (b)	ALLOWABLE TOLERANCE
All	0.008" per inch of outside dimension 0.008" minimum

**STANDARD TOLERANCES
PLATE**

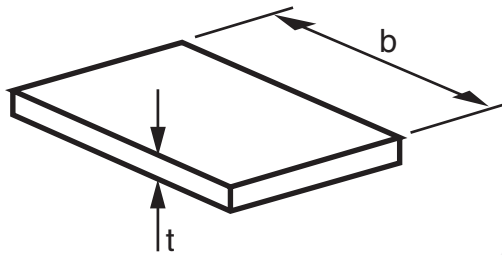

NOMINAL PLATE WIDTH	DIMENSION	TOLERANCE	ALLOWABLE TOLERANCE
48"	t = thickness	- 10% of thickness	- 0.040" maximum
	b = width	± 3% of the width	± 0.094" maximum
60"	b = width	- 3/16", + 0"	59-13/16" - 60"

CAMBER

As per ASTM D3917, camber is the allowable deviation of the side from a straight line.

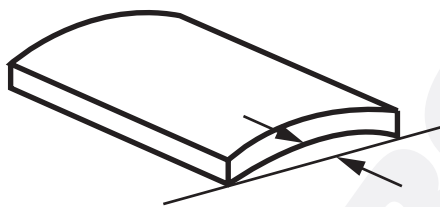

THICKNESS	ALLOWABLE TOLERANCE (in)
All	0.025" times the length in feet

**STANDARD TOLERANCES
MISCELLANEOUS**

CUT LENGTHS

SPECIFIED LENGTHS (ft)	ALLOWABLE TOLERANCE*
to 8'	- 0", + 0.250"
> 8' - 20'	- 0", + 0.375"
> 20' - 24'	- 0", + 0.500"
> 24'	- 0", + 3.000"

**Applies only to structural shapes and plate.*

SQUARENESS OF END CUT

SHAPE	ALLOWABLE TOLERANCE
Plate	± 1°
Other EXTREN® Shapes	± 1°