

SECTION 11

FIBREBOLT® STUDS AND NUTS



Look for this blue line in the left margin of the Design Manual documents. This line shows you where the latest update has been made.

FIBREBOLT® STUDS AND NUTS

STANDARD COLOR—BROWN

SHAPE—HEX

For structural applications where mechanical fasteners must not only be strong, but also non-corrosive and/or non-conductive, **FIBREBOLT®** fiberglass studs and nuts can be used in place of steel or other metal fasteners.

FIBREBOLT® is being utilized in chemical process equipment, air and water pollution control equipment, marine applications electrical equipment and in general industry.

FIBREBOLT® is available in diameters of 3/8", 1/2", 5/8", 3/4" and 1" with nuts for immediate delivery. Four foot lengths are standard. Other lengths are available on request. Custom partial length threading is also available on request.

	TEST METHOD	3/8" - 16	1/2" - 13	5/8" - 11	3/4" - 10	1" - 8
Ultimate tensile load using Strongwell fiberglass nut (lb.) ①		1,050	2,000	3,100	4,500	6,500
Ultimate tensile load using two (2) Strongwell fiberglass nuts (lb.) ①		1,470	2,800	4,340	6,300	9,700
Transverse shear on threaded rod - double shear (min. load lb.) ①	ASTM-B-565	3,000	5,000	7,500	12,000	22,000
Transverse shear on threaded rod - single shear (min. load lb.) ①		1,600	2,600	3,800	6,200	11,200
Compressive strength - longitudinal, without nuts (min. psi)	ASTM-D-695	60,000	60,000	60,000	60,000	60,000
Flexural strength (min. psi) ①	ASTM-D-790	50,000	50,000	50,000	50,000	50,000
Flexural modulus (min. psi x 10 ⁶) ①	ASTM-D-790	2.00	2.00	2.00	2.50	2.75
Dielectric strength ASTM-D-149 (kv/in.)		35	35	35	35	35
Water absorption 24 hr. immersion - threaded with cut ends sealed	ASTM-D-570	1%	1%	1%	1%	1%
Coefficient of thermal expansion - longitudinal (in./in./°F)		5 x 10 ⁻⁶	5 x 10 ⁻⁶	5 x 10 ⁻⁶	5 x 10 ⁻⁶	5 x 10 ⁻⁶
Max recommended operation temperature - based on 50% retention of ultimate thread shear strength °F		203°F	203°F	203°F	203°F	203°F
Flammability	ASTM-D-635	Self-Extinguishing on All				
Stud weight (lb./ft.)		0.07	0.12	0.18	0.28	0.50
Thickness of nut and washer in inches		3/4"	7/8"	1-1/8"	1-1/4"	1-5/8"
Diameter of washer in inches		1"	1-1/8"	1-5/16"	1-1/2"	2"

① Strength values are minimums derived from multiple production sample testings.

NOTES

- All test results are for bolts with single nuts only unless otherwise specified.
- Appropriate safety factors must be applied.
- Properties above do not apply when fiberglass stud is used with metal nut. No data has been generated for metal nuts. If metal nuts are used, strengths will be reduced because of less thread engagement. If metal nuts are used, extreme care should be taken to assure that the threads match and that a snug fit is achieved.
- Threads do not meet Class 1, 2 or 3 ANSI/ASME standard.

FIBREBOLT® STUDS AND NUTS USER'S GUIDE

FIBREBOLT® studs are pultruded, fiberglass reinforced vinyl ester threaded rods and thermoplastic hex-shaped nuts. The properties and characteristics of **FIBREBOLT®** differ from steel. Failure to follow the procedure below can result in damage and/or premature failure to the stud/nut assembly.

PROCEDURE

1. If nuts are to be removed during application, it is recommended that they be installed dry. A light oil, dry lubricant, or silicone spray may be used if needed.
2. Bearing surfaces of the nuts must be parallel to the surfaces being fastened.
3. A torque wrench must be used. See the table below:

Size	Ultimate Torque Strength	Recommended Maximum Installation Torque
3/8" - 16	8 ft. - lbs.	4 ft. - lbs.
1/2" - 13	18 ft. - lbs.	8 ft. - lbs.
5/8" - 11	35 ft. - lbs.	16 ft. - lbs.
3/4" - 10	50 ft. - lbs.	24 ft. - lbs.
1" - 8	110 ft. - lbs.	50 ft. - lbs.

4. Wrenches must make full contact with all nut edges. Partial contact will cause the corners to fracture, affecting the performance of the stud/nut assembly. A standard six point socket is recommended for the hex nuts.
5. For assemblies in which the nut will not be subsequently removed, the stud/nut assembly should be coated with adhesive or resin to insure that the nuts do not loosen. The adhesive or resin shall act as the lubricant - do not use any oils, dry lubricants or silicone sprays. After the nut is tightened to the proper torque value, coat the entire nut and exposed stud assembly with a thick layer of adhesive or resin.
6. The **FIBREBOLT®** stud has cut and coated threads. **FIBREBOLT®** that will be exposed to harsh environments should have the threads resealed and cut ends sealed. If removal of the nut is anticipated, a very thin (1 mil) sprayed-on coat of polyurethane, resin, or adhesive are recommended where possible.
7. Property values were obtained for static conditions. Vibration should be eliminated or minimized in applications utilizing **FIBREBOLT®**.

CAUTION

1. All data regarding the **FIBREBOLT®** stud and nut assembly has been generated from tests involving only fiberglass nuts. No data has been generated for metal nuts. If metal nuts are used, strengths will be reduced because of less thread engagement. If metal nuts are used, extreme care should be taken to assure that the threads match and that a snug fit is achieved.
2. The **FIBREBOLT®** stud has cut, not molded threads. Threads that will be exposed to environments that might attack the glass reinforcements should be sealed after installation. If removal of the nut is anticipated, a very thin (1 mil) sprayed-on coat of polyurethane will normally be effective. Heavier coats of polyurethane, resin, or adhesive are recommended where possible.

FIBREBOLT® STUDS AND NUTS USER'S GUIDE

FIBREBOLT® NUTS

The hex shaped thermoplastic nut in Strongwell's **FIBREBOLT®** fastener system is manufactured from fiberglass reinforced PPS resin. The standard color is brown.

NOTE: **FIBREBOLT®** studs and nuts should be used together as a system to assure proper fit and properties. Interchange with other manufacturer's bolt or nut is not intended or assured.

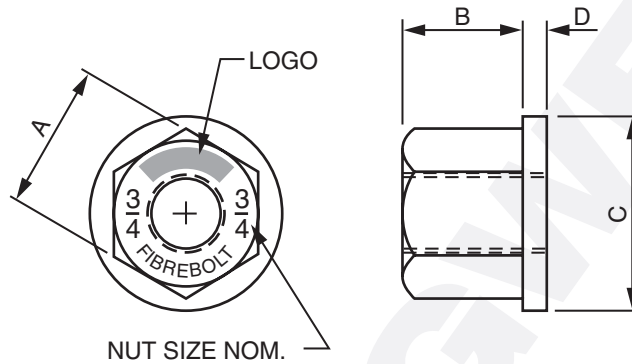

FIBREBOLT® NUT

HEX NUT DIMENSIONS

Nut Size Nom.	Width Across Flats "A"	Nom. Width Across Flats	Thickness "B"	Washer Dia. "C"	Washer Thickness "D"
3/8" - 16	0.745	3/4"	5/8"	1"	1/8"
1/2" - 13	0.870	7/8"	3/4"	1-1/8"	1/8"
5/8" - 11	1.057	1-1/16"	15/16"	1-5/16"	3/16"
3/4" - 10	1.245	1-1/4"	1-1/16"	1-1/2"	3/16"
1" - 8	1.620	1-5/8"	1-3/8"	2"	1/4"