

SECTION 12 - FIBERGLASS GRATING

Table of Contents

DURAGRATE® Molded Fiberglass Grating

Introduction to DURAGRATE® / How to Specify.....	12-2
DURAGRATE® Uniform Load/Deflection Table.....	12-3, 12-4
DURAGRATE® Concentrated Line Load/Deflection Table	12-5, 12-6
DURAGRATE® Concentrated Point Load/Deflection Table.....	12-7, 12-8

PULTRUDED FIBERGLASS GRATING

Introduction to DURADEK®.....	12-9
Introduction to DURAGRID® & DURAGRID® Phenolic	12-10
Evolution of Pultruded Grating.....	12-11, 12-12
Pultruded Grating Panel Sizes & Availability	12-13
DURAGRID® Stair Treads & Landings and Fasteners	12-14

DURADEK® Pultruded Fiberglass Grating

How to Specify DURADEK®	12-15
DURADEK® Uniform Load/Deflection Table.....	12-16
DURADEK® Concentrated Load/Deflection Table.....	12-17

DURAGRID® Pultruded Fiberglass Grating

How to Specify DURAGRID®.....	12-18
DURAGRID® I-Bar Simple Specs	12-19
DURAGRID® T-Bar Simple Specs.....	12-20
DURAGRID® HD Simple Specs.....	12-21
DURAGRID® R-Bar Simple Specs	12-22

DURAGRID® Phenolic Pultruded Fiberglass Grating

How to Specify DURAGRID® Phenolic Grating	12-23
DURAGRID® Uniform Load/Deflection Table	12-24, 12-25
DURAGRID® Concentrated Load/Deflection Table	12-26, 12-27

SECTION 12

FIBERGLASS GRATING

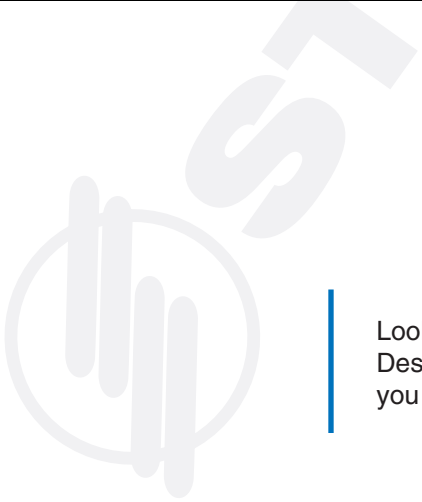
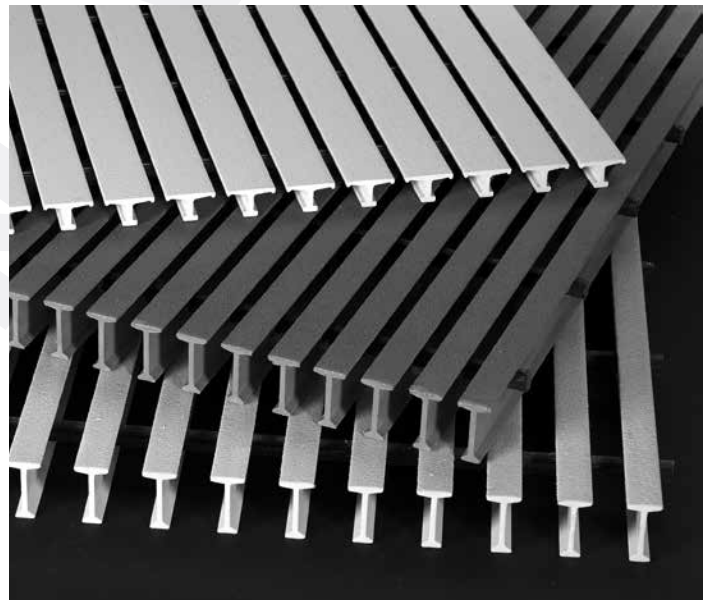
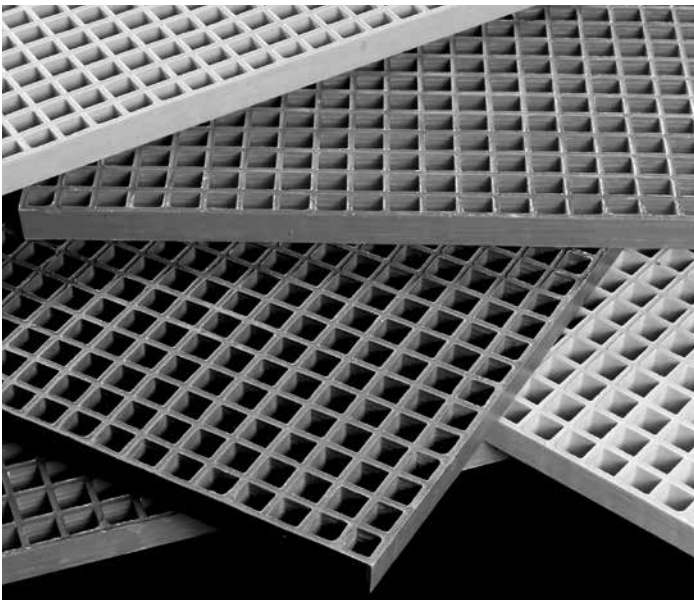

Look for this blue line in the left margin of the Design Manual documents. This line shows you where the latest update has been made.

DURAGRATE® MOLDED FIBERGLASS GRATING

INTRODUCTION TO DURAGRATE®

DURAGRATE® molded fiberglass grating is a premium-quality mesh grating panel made exclusively in the U.S.A. While molded grating is a chemical resistant flooring choice for many industrial applications, **DURAGRATE®** offers performance and quality superior to imported suppliers.

DURAGRATE® panels are molded in one piece and feature a concave non-slip walking surface. The panels allow for efficient on-site cutting to minimize grating waste. Load bearing bars in both directions allow for use without continuous side support.

DURAGRATE® molded fiberglass grating weighs significantly less than metal gratings while a high resin content provides excellent corrosion resistance which requires very little maintenance. A high glass content offers greater stiffness and strength resulting in a higher safety factor. **DURAGRATE®** molded fiberglass grating is composed of fiberglass rovings combined with a thermosetting resin. All of the resins contain a UV inhibitor. Standard **DURAGRATE®** grating has a concave profile on the upper surface for skid resistance. Grit tops are available upon request. Standard colors are dark gray, green, yellow, orange, red, and light gray. Custom colors are available upon request.

RESIN SYSTEMS AVAILABLE

	RESIN CODE	DESCRIPTION	RESIN BASE	CORROSION RESISTANCE	FLAME SPREAD INDEX**	SMOKE-DEVELOPED INDEX**
STANDARD	VE	Chemical Proof Fire Retardant	Vinyl Ester	Excellent	Class A, 25 or less	Class A, 450 or less
	ISO	Industrial Grade Fire Retardant	Isophthalic	Very Good	Class A, 25 or less	Class A, 450 or less
	FF	Food Grade Fire Retardant	Isophthalic	Very Good	Class A, 25 or less	Class A, 450 or less

** Per ASTM E-84 Tunnel Test. DURAGRATE® panels are tested with the flame impinging the top side of the panel and separately with the flame impinging the bottom side of the panel. This ensures Class A performance is met in both configurations.

Corrosion information for these resins is listed in Section 22 — **CORROSION RESISTANCE GUIDE**.

HOW TO SPECIFY DURAGRATE®

The molded fiberglass grating shall be **DURAGRATE®** as supplied by Strongwell. Grating panels shall be manufactured in the U.S.A. according to the standards set by the Fiberglass Grating Manufacturers Council (FGMC). Grating panels shall be (pick one from chart for thickness, mesh pattern, resin code) molded grid pattern. The grating shall be one-piece construction with the tops of the bearing bars and cross bars in the same plane. Surface shall be concave top or gritted.

SHAPES, SIZES, AND AVAILABILITY

Standard DURAGRATE® Panels							
THICKNESS	MESH PATTERN	PANEL SIZE	A (PER FT. OF WIDTH)	I (PER FT. OF WIDTH)	S (PER FT. OF WIDTH)	OPEN AREA	APPROX. WEIGHT
1"	2" Square	4' x 12'	1.44 in. ²	0.12 in. ⁴	0.24 in. ³	72%	2.4 lbs/ft. ²
1"	1-1/2" Square	3' x 10' 4' x 12'	1.71 in. ²	0.14 in. ⁴	0.29 in. ³	70%	2.6 lbs/ft. ²
1"	1" x 4" Rectangular	3' x 10' 4' x 12'	2.57 in. ²	0.22 in. ⁴	0.43 in. ³	69%	2.8 lbs/ft. ²
1"	3/4" x 4" Rectangular	4' x 12'	3.84 in. ²	0.32 in. ⁴	0.64 in. ³	63%	2.9 lbs/ft. ²
1-1/2"	1-1/2" Square	3' x 10' 4' x 12' 5' x 10' 5' x 12'	2.85 in. ²	0.51 in. ⁴	0.65 in. ³	70%	3.8 lbs/ft. ²
1-1/2" Mini Mesh	3/4" x 3/4" on Center (Top), 1-1/2" x 1-1/2" on Center (Bottom)	4' x 12'	3.77 in. ²	0.71 in. ⁴	0.79 in. ³	44%	4.5 lbs/ft. ²
1-1/2"	1" x 2" Rectangular HD	4' x 6'	6.48 in. ²	1.22 in. ⁴	1.62 in. ³	51%	6.0 lbs/ft. ²
2"	2" Square	4' x 12'	2.88 in. ²	0.96 in. ⁴	0.94 in. ³	72%	4.0 lbs/ft. ²

NOTE: Custom panel sizes and resins are available upon request. Descriptions of available resin systems are located on the previous page. Please contact Sales Director or Account Manager for assistance.

DURAGRATE® UNIFORM LOAD / DEFLECTION

LOAD TABLES FOR STANDARD RESIN SYSTEMS

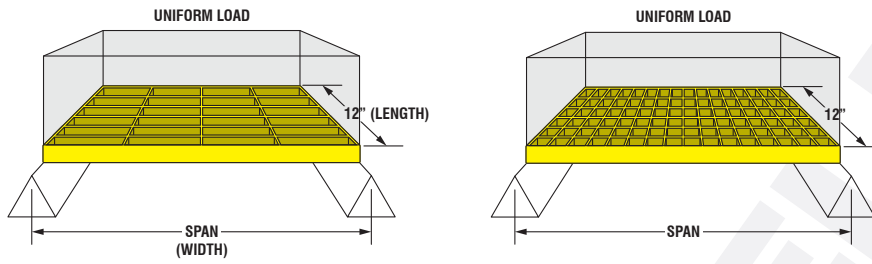

LOAD in LB / SQUARE FOOT (PSF)

SPAN INCHES	STYLE		60	100	150	200	250	500	1000	2000	MAXIMUM RECOMMENDED LOAD (PSF)	APPARENT EI (10 ⁶ LB-IN ²) / FT of WIDTH
	DEPTH	MESH										
12	1"	2" x 2"	0.01	0.01	0.02	0.02	0.03	0.06	0.11		1240	0.2
	1"	1-1/2" x 1-1/2"	<0.01	0.01	0.01	0.02	0.02	0.04	0.08		1800	0.3
	1"	1" x 4"	<0.01	0.01	0.01	0.02	0.02	0.04	0.08		1960	0.3
	1"	3/4" x 4"	<0.01	0.01	0.01	0.01	0.01	0.03	0.06		2660	0.4
	1-1/2"	1-1/2" x 1-1/2"	<0.01	<0.01	<0.01	0.01	0.01	0.02	0.03	0.06	3720	0.7
	1-1/2"	3/4" x 3/4"	<0.01	<0.01	<0.01	0.01	0.01	0.01	0.03	0.06	3720	0.8
	2"	2" x 2"	<0.01	<0.01	<0.01	<0.01	0.01	0.01	0.02	0.05	4280	1.0
18	1"	2" x 2"	0.03	0.06	0.09	0.11	0.14				527	0.2
	1"	1-1/2" x 1-1/2"	0.02	0.04	0.06	0.08	0.09				760	0.3
	1"	1" x 4"	0.02	0.03	0.04	0.06	0.07	0.14			949	0.4
	1"	3/4" x 4"	0.02	0.03	0.04	0.06	0.07	0.14	0.28		1067	0.4
	1-1/2"	1-1/2" x 1-1/2"	0.01	0.01	0.02	0.02	0.03	0.06	0.11		1900	1.0
	1-1/2"	3/4" x 3/4"	0.01	0.01	0.02	0.02	0.03	0.05	0.10		1900	1.1
	2"	2" x 2"	<0.01	0.01	0.01	0.02	0.02	0.04	0.08	0.16	2400	1.4
24	1"	2" x 2"	0.11	0.18	0.27	0.36	0.45				265	0.2
	1"	1-1/2" x 1-1/2"	0.07	0.12	0.18	0.24	0.30				410	0.3
	1"	1" x 4"	0.05	0.09	0.14	0.18	0.23				534	0.4
	1"	3/4" x 4"	0.04	0.07	0.11	0.14	0.18	0.36			600	0.5
	1-1/2"	1-1/2" x 1-1/2"	0.02	0.03	0.05	0.07	0.08	0.16			1190	1.1
	1-1/2"	3/4" x 3/4"	0.02	0.03	0.05	0.06	0.08	0.15			1190	1.2
	2"	2" x 2"	0.01	0.02	0.03	0.05	0.06	0.11	0.23		1450	1.6
30	1"	2" x 2"	0.26	0.44							160	0.2
	1"	1-1/2" x 1-1/2"	0.18	0.29							256	0.3
	1"	1" x 4"	0.13	0.22							336	0.4
	1"	3/4" x 4"	0.11	0.18	0.26	0.35	0.44				388	0.5
	1-1/2"	1-1/2" x 1-1/2"	0.05	0.08	0.12	0.16	0.20				760	1.1
	1-1/2"	3/4" x 3/4"	0.04	0.07	0.11	0.15	0.18				760	1.2
	2"	2" x 2"	0.03	0.05	0.08	0.10	0.13	0.26			904	1.7

Note: 1" thick by 1" x 4" rectangular mesh grating panels are only available with a grit surface.

Note: 1-1/2" thick by 1" x 2" rectangular mesh deflection data is not included here, contact Strongwell for more information.

DURAGRATE® UNIFORM LOAD / DEFLECTION

LOAD in LB / SQUARE FOOT (PSF)

SPAN INCHES	STYLE		60	100	150	200	250	500	1000	2000	MAXIMUM RECOMMENDED LOAD (PSF)	APPARENT EI (10 ⁶ LB-IN ²) / FT of WIDTH
	DEPTH	MESH										
36	1"	2" x 2"	0.55	0.91							93	0.2
	1"	1-1/2" x 1-1/2"	0.36	0.61							180	0.3
	1"	1" x 4"	0.27	0.46							237	0.4
	1"	3/4" x 4"	0.22	0.36	0.55						247	0.5
	1-1/2"	1-1/2" x 1-1/2"	0.09	0.15	0.23						493	1.2
	1-1/2"	3/4" x 3/4"	0.08	0.14	0.21						493	1.3
	2"	2" x 2"	0.06	0.10	0.14	0.19					607	1.9
42	1-1/2"	1-1/2" x 1-1/2"	0.18	0.31							337	1.1
	1-1/2"	3/4" x 3/4"	0.17	0.28							337	1.2
	2"	2" x 2"	0.10	0.17	0.25	0.34					446	2.0
48	1-1/2"	1-1/2" x 1-1/2"	0.35								220	1.0
	1-1/2"	3/4" x 3/4"	0.29								220	1.2
	2"	2" x 2"	0.17	0.29	0.43						340	2.0
54	1-1/2"	1-1/2" x 1-1/2"	0.55								157	1.0
	1-1/2"	3/4" x 3/4"	0.46								157	1.2
	2"	2" x 2"	0.28	0.46							267	2.0
60	2"	2" x 2"	0.42								212	2.0

Note: 1" thick by 1" x 4" rectangular mesh grating panels are only available with a grit surface.

Note: 1-1/2" thick by 1" x 2" rectangular mesh deflection data is not included here, contact Strongwell for more information.



DURAGRATE® CONCENTRATED LINE LOAD / DEFLECTION

LOAD TABLES FOR STANDARD RESIN SYSTEMS

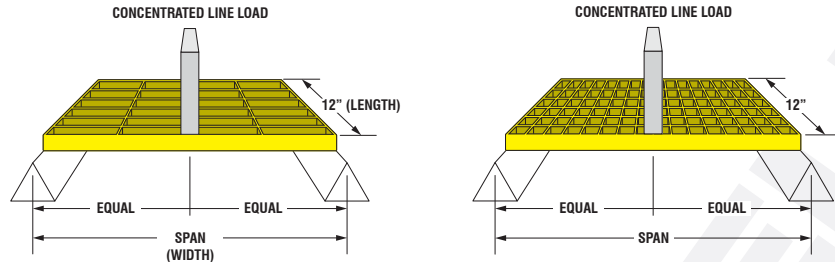

LOAD in LB / FOOT of WIDTH

SPAN INCHES	STYLE		50	100	150	200	250	500	1000	2000	MAXIMUM RECOMMENDED LOAD (LB/FT)	APPARENT EI (10 ⁶ LB-IN ²) / FT of WIDTH
	DEPTH	MESH										
12	1"	2" x 2"	0.02	0.03	0.05	0.06	0.07	0.12			620	0.2
	1"	1-1/2" x 1-1/2"	0.01	0.01	0.02	0.03	0.04	0.07			900	0.3
	1"	1" x 4"	<0.01	0.01	0.02	0.02	0.03	0.06	0.12		980	0.3
	1"	3/4" x 4"	0.01	0.02	0.03	0.04	0.04	0.07	0.11		1330	0.4
	1-1/2"	1-1/2" x 1-1/2"	<0.01	<0.01	<0.01	0.01	0.01	0.02	0.05	0.1	1860	0.7
	1-1/2"	3/4" x 3/4"	<0.01	<0.01	<0.01	0.01	0.01	0.02	0.05	0.09	1860	0.8
	2"	2" x 2"	<0.01	<0.01	<0.01	0.01	0.01	0.02	0.04	0.07	2140	1.0
18	1"	2" x 2"	0.04	0.07	0.10	0.14	0.17				395	0.2
	1"	1-1/2" x 1-1/2"	0.02	0.04	0.07	0.09	0.11				570	0.3
	1"	1" x 4"	0.02	0.03	0.05	0.06	0.08	0.16			712	0.4
	1"	3/4" x 4"	0.02	0.04	0.05	0.07	0.08	0.13	0.28		800	0.4
	1-1/2"	1-1/2" x 1-1/2"	<0.01	0.01	0.01	0.02	0.03	0.06	0.12		1425	1.0
	1-1/2"	3/4" x 3/4"	<0.01	0.01	0.01	0.02	0.03	0.06	0.11		1425	1.1
	2"	2" x 2"	<0.01	0.01	0.01	0.02	0.02	0.04	0.09	0.17	1800	1.4
24	1"	2" x 2"	0.09	0.17	0.25	0.33	0.41				265	0.2
	1"	1-1/2" x 1-1/2"	0.05	0.10	0.15	0.20	0.24				410	0.3
	1"	1" x 4"	0.04	0.07	0.11	0.15	0.19				534	0.4
	1"	3/4" x 4"	0.04	0.07	0.09	0.12	0.15	0.29			600	0.5
	1-1/2"	1-1/2" x 1-1/2"	0.01	0.02	0.04	0.05	0.06	0.13			1190	1.1
	1-1/2"	3/4" x 3/4"	0.01	0.02	0.04	0.05	0.06	0.12			1190	1.2
	2"	2" x 2"	<0.01	0.01	0.02	0.03	0.04	0.09	0.18		1450	1.6
30	1"	2" x 2"	0.15	0.3	0.44						200	0.2
	1"	1-1/2" x 1-1/2"	0.09	0.19	0.28						320	0.3
	1"	1" x 4"	0.07	0.14	0.21	0.28					420	0.4
	1"	3/4" x 4"	0.06	0.11	0.17	0.23	0.28	0.56			485	0.5
	1-1/2"	1-1/2" x 1-1/2"	0.02	0.05	0.07	0.10	0.12	0.25			950	1.1
	1-1/2"	3/4" x 3/4"	0.02	0.05	0.07	0.09	0.12	0.23			950	1.2
	2"	2" x 2"	0.01	0.03	0.05	0.06	0.08	0.16			1130	1.7

Note: 1" thick by 1" x 4" rectangular mesh grating panels are only available with a grit surface.

Note: 1-1/2" thick by 1" x 2" rectangular mesh deflection data is not included here, contact Strongwell for more information.

DURAGRATE® CONCENTRATED LINE LOAD / DEFLECTION

LOAD in LB / FOOT of WIDTH

SPAN INCHES	STYLE		50	100	150	200	250	500	1000	2000	MAXIMUM RECOMMENDED LOAD (LB/FT)	APPARENT EI (10 ⁶ LB-IN ²) / FT of WIDTH
	DEPTH	MESH										
36	1"	2" x 2"	0.24	0.48							140	0.2
	1"	1-1/2" x 1-1/2"	0.15	0.30							270	0.3
	1"	1" x 4"	0.12	0.24							356	0.4
	1"	3/4" x 4"	0.10	0.19	0.28	0.37	0.46				370	0.5
	1-1/2"	1-1/2" x 1-1/2"	0.04	0.08	0.12	0.16	0.20				740	1.2
	1-1/2"	3/4" x 3/4"	0.04	0.07	0.11	0.15	0.19				740	1.3
	2"	2" x 2"	0.02	0.05	0.07	0.10	0.12	0.25			910	1.9
42	1"	1-1/2" x 1-1/2"	0.24								220	0.3
	1"	1" x 4"	0.19	0.39							304	0.4
	1"	3/4" x 4"	0.15	0.31	0.46						315	0.5
	1-1/2"	1-1/2" x 1-1/2"	0.07	0.14	0.21	0.28	0.35				590	1.1
	1-1/2"	3/4" x 3/4"	0.06	0.13	0.19	0.26	0.32				590	1.2
	2"	2" x 2"	0.03	0.07	0.11	0.15	0.19				780	2.0
48	1-1/2"	1-1/2" x 1-1/2"	0.11	0.23	0.34	0.46					440	1.0
	1-1/2"	3/4" x 3/4"	0.10	0.19	0.29	0.38					440	1.2
	2"	2" x 2"	0.05	0.11	0.17	0.23	0.28				680	2.0
54	1-1/2"	1-1/2" x 1-1/2"	0.16	0.33							354	1.0
	1-1/2"	3/4" x 3/4"	0.14	0.27							354	1.2
	2"	2" x 2"	0.08	0.16	0.24	0.32	0.41				600	2.0
60	2"	2" x 2"	0.11	0.22	0.33	0.45					530	2.0

Note: 1" thick by 1" x 4" rectangular mesh grating panels are only available with a grit surface.

Note: 1-1/2" thick by 1" x 2" rectangular mesh deflection data is not included here, contact Strongwell for more information.

DURAGRATE® CONCENTRATED POINT LOAD / DEFLECTION

Note: This loading criteria is not recognized by Fiberglass Composites Grating Manual

LOAD TABLES FOR STANDARD RESIN SYSTEMS

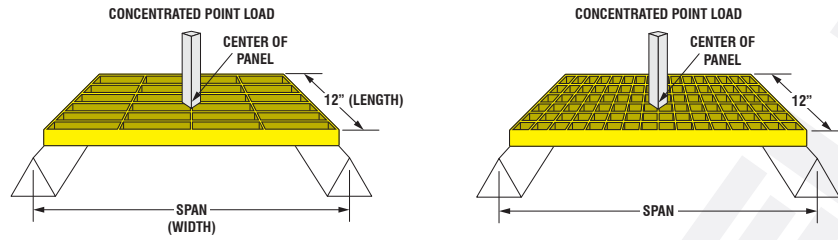

LOAD in LB

SPAN INCHES	STYLE		50	100	150	200	250	500	1000	2000	APPARENT EI (10 ⁶ LB-IN ²) / FT of WIDTH
	DEPTH	MESH									
12	1"	2" x 2"	<0.01	<0.01	<0.01	<0.01	0.01	0.02	0.05	0.09	0.2
	1"	1-1/2" x 1-1/2"	<0.01	<0.01	<0.01	<0.01	<0.01	0.02	0.03	0.06	0.3
	1"	1" x 4"	<0.01	<0.01	<0.01	<0.01	<0.01	0.02	0.03	0.06	0.3
	1"	3/4" x 4"	<0.01	<0.01	<0.01	<0.01	<0.01	0.01	0.02	0.05	0.4
	1-1/2"	1-1/2" x 1-1/2"	<0.01	<0.01	<0.01	<0.01	<0.01	<0.01	0.01	0.03	0.7
	1-1/2"	3/4" x 3/4"	<0.01	<0.01	<0.01	<0.01	<0.01	<0.01	0.01	0.02	0.8
18	1"	2" x 2"	<0.01	0.02	0.02	0.03	0.04	0.08	0.15	0.30	0.2
	1"	1-1/2" x 1-1/2"	<0.01	0.01	0.02	0.02	0.03	0.05	0.10	0.20	0.3
	1"	1" x 4"	<0.01	<0.01	0.01	0.02	0.02	0.04	0.08	0.15	0.4
	1"	3/4" x 4"	<0.01	<0.01	0.01	0.02	0.02	0.04	0.08	0.15	0.4
	1-1/2"	1-1/2" x 1-1/2"	<0.01	<0.01	<0.01	<0.01	<0.01	0.02	0.03	0.06	1.0
	1-1/2"	3/4" x 3/4"	<0.01	<0.01	<0.01	<0.01	<0.01	0.01	0.03	0.06	1.1
24	2"	2" x 2"	<0.01	<0.01	<0.01	<0.01	<0.01	0.01	0.02	0.04	1.4
	1"	2" x 2"	0.02	0.04	0.05	0.07	0.09	0.18	0.36		0.2
	1"	1-1/2" x 1-1/2"	0.01	0.02	0.04	0.05	0.06	0.12	0.24		0.3
	1"	1" x 4"	<0.01	0.02	0.03	0.04	0.05	0.09	0.18	0.36	0.4
	1"	3/4" x 4"	<0.01	0.01	0.02	0.03	0.04	0.07	0.14	0.29	0.5
	1-1/2"	1-1/2" x 1-1/2"	<0.01	<0.01	<0.01	0.01	0.02	0.03	0.07	0.13	1.1
30	1-1/2"	3/4" x 3/4"	<0.01	<0.01	<0.01	0.01	0.02	0.03	0.06	0.12	1.2
	2"	2" x 2"	<0.01	<0.01	<0.01	<0.01	0.01	0.02	0.05	0.09	1.6
	1"	2" x 2"	0.04	0.07	0.11	0.14	0.18	0.35			0.2
	1"	1-1/2" x 1-1/2"	0.02	0.05	0.07	0.09	0.12	0.23			0.3
	1"	1" x 4"	0.02	0.04	0.05	0.07	0.09	0.18	0.35		0.4
	1"	3/4" x 4"	0.01	0.03	0.04	0.06	0.07	0.14	0.28		0.5
30	1-1/2"	1-1/2" x 1-1/2"	<0.01	0.01	0.02	0.03	0.03	0.06	0.13		1.1
	1-1/2"	3/4" x 3/4"	<0.01	0.01	0.02	0.02	0.03	0.06	0.12		1.2
	2"	2" x 2"	<0.01	<0.01	0.01	0.02	0.02	0.04	0.08	0.17	1.7

Note: 1" thick by 1" x 4" rectangular mesh grating panels are only available with a grit surface.

Note: 1-1/2" thick by 1" x 2" rectangular mesh deflection data is not included here, contact Strongwell for more information.

DURAGRATE® CONCENTRATED POINT LOAD / DEFLECTION

Note: This loading criteria is not recognized by Fiberglass Composites Grating Manual

LOAD in LB

SPAN INCHES	STYLE		50	100	150	200	250	500	1000	2000	APPARENT EI (10 ⁶ LB-IN ²) / FT of WIDTH
	DEPTH	MESH									
36	1"	2" x 2"	0.06	0.12	0.18	0.24	0.30				0.2
	1"	1-1/2" x 1-1/2"	0.04	0.08	0.12	0.16	0.20				0.3
	1"	1" x 4"	0.03	0.06	0.09	0.12	0.15	0.30			0.4
	1"	3/4" x 4"	0.02	0.05	0.07	0.10	0.12	0.24			0.5
	1-1/2"	1-1/2" x 1-1/2"	0.01	0.02	0.03	0.04	0.05	0.10	0.20		1.2
	1-1/2"	3/4" x 3/4"	<0.01	0.02	0.03	0.04	0.05	0.09	0.19		1.3
	2"	2" x 2"	<0.01	0.01	0.02	0.03	0.03	0.06	0.13	0.26	1.9
42	1"	1-1/2" x 1-1/2"	0.06	0.13	0.19	0.26					0.3
	1"	1" x 4"	0.05	0.10	0.14	0.19	0.24				0.4
	1"	3/4" x 4"	0.04	0.08	0.12	0.15	0.19				0.5
	1-1/2"	1-1/2" x 1-1/2"	0.02	0.04	0.05	0.07	0.09	0.18	0.35		1.1
	1-1/2"	3/4" x 3/4"	0.02	0.03	0.05	0.06	0.08	0.16	0.32		1.2
	2"	2" x 2"	<0.01	0.02	0.03	0.04	0.05	0.10	0.19		2.0
48	1-1/2"	1-1/2" x 1-1/2"	0.03	0.06	0.09	0.12	0.14	0.29			1.0
	1-1/2"	3/4" x 3/4"	0.02	0.05	0.07	0.10	0.12	0.24			1.2
	2"	2" x 2"	0.01	0.03	0.04	0.06	0.07	0.14	0.29		2.0
54	1-1/2"	1-1/2" x 1-1/2"	0.04	0.08	0.12	0.16	0.21				1.0
	1-1/2"	3/4" x 3/4"	0.03	0.07	0.10	0.14	0.17				1.2
	2"	2" x 2"	0.02	0.04	0.06	0.08	0.10	0.21			2.0
60	2"	2" x 2"	0.03	0.06	0.08	0.11	0.14	0.28			2.0

Note: 1" thick by 1" x 4" rectangular mesh grating panels are only available with a grit surface.

Note: 1-1/2" thick by 1" x 2" rectangular mesh deflection data is not included here, contact Strongwell for more information.

DURADEK® FIBERGLASS GRATING

INTRODUCTION TO DURADEK®

DURADEK® fiberglass grating is a pultruded bar type grating manufactured by Strongwell-Chatfield Location. This grating can be designed and used like traditional metal grates. The individual bearing bars are either “I” bar or “T” bar shapes chosen for their economy and efficiency of design.

The available colors are light gray and yellow.

DURADEK® fiberglass grating is produced in fire retardant polyester resin. This resin is a premium grade fire retardant polyester with antimony trioxide added. This system exceeds the requirements for Class 1 flame rating of 25 or less per ASTM E-84 and meets the self-extinguishing requirements of ASTM D-635. The bars with this resin have a surfacing veil and a UV inhibitor for UV protection. This resin is available with bearing bars in either yellow or light gray and identified as YFRPE or GFRPE.

Also available as an option is a premium grade vinyl ester resin for severe corrosion applications. Vinyl ester has better resistance to caustic and certain acid environments than polyester resin. This resin also meets the ASTM E-84 Class 1 flame rating. The bars made with this resin have a surfacing veil and a UV inhibitor for UV protection. This resin is available with bearing bars in either yellow or light gray and identified as YFRVE or GFRVE.

Corrosion information for these resins is listed in Section 22 — **CORROSION RESISTANCE GUIDE**. Other special resin systems and colors are available in the line specified as DURAGRID®.

Each bearing bar is reinforced by a core of densely packed continuous glass fibers wrapped by a continuous glass mat plus a synthetic surfacing veil which provides a 100% pure resin surface for added corrosion resistance. The densely packed core makes the bars very rigid and strong in the longitudinal direction. The continuous glass mat gives the bar strength in the transverse direction to protect them from chipping, cracking and lineal fracturing along with giving each bar a resin-rich surface.

The bearing bars are assembled into panels of grating by a unique patented* cross-rod system. The cross-rod system consists of two continuous pultruded spacer bars and a center core wedge. The spacers are notched at each bearing bar so the bars are both mechanically locked and chemically bonded to the web of each bearing bar. The wedge is, in turn, bonded to the spacers to form a strong and rigid cross-rod support system that resists twist, prevents lateral movement of the bearing bars, and transfers load from one bar to the next.

The cross-rod support system allows **DURADEK®** grating to be cut and fabricated like a solid sheet. Just coat the cut end with a resin sealer and install. If more installation information is needed, ask for Strongwell’s *Grating Field Fabrication Guide*.

The top of the **DURADEK®** grating is covered with a permanently bonded, grit-baked epoxy, anti-skid surface. This surface assures a safe, anti-skid walkway.

* U.S. Patent No. 4,522,009
Canadian Patent No. 1,211,270

DURAGRID® & DURAGRID® PHENOLIC FIBERGLASS GRATING

INTRODUCTION TO DURAGRID® AND DURAGRID® PHENOLIC

DURAGRID® Custom Fiberglass Grids and Grating

DURAGRID® is the registered product tradename for the non-standard, non-stocked pultruded grating manufactured by Strongwell. Strongwell can custom manufacture grid or grating systems to accommodate specific plant applications that cannot effectively be met by a standard line of fiberglass grating. **DURAGRID®** offers such options as selection of open space, bar shape, cross rod placement, custom fabrication, custom resin or color. Often a grid or grating system tailored to the demands of a specific application will not only do the job better, but also be more cost effective than trying to adapt standard grating to a specific situation.

Data on some of the more common custom gratings are included herein. Refer to the load/deflection tables for selection.

DURAGRID® Phenolic

DURAGRID® Phenolic is a fire resistant pultruded grating manufactured by Strongwell-Chatfield using phenolic resin and continuous glass fibers wrapped by a continuous strand glass mat. **DURAGRID®** Phenolic grating generates much less smoke and toxic fumes when exposed to fire than traditional FRP products. **DURAGRID®** Phenolic grating meets or exceeds USA Fire Safety Standards. It is accepted for use in locations and applications as allowed in the ASTM F3059 Matrix guide for fiberglass grating meeting Structural Fire Integrity Level 2 (L2). It also complies with Annex 1 (Resolution MSC.307(88) , Part 2, 2.41 and 2.4.2 (smoke and toxicity testing) of the FTP Code (International Code for Application of Fire Test Procedures) - (MSC 88/26/ Add.2) issued by the International Maritime Organization (IMO).

If Coast Guard PFM 2-98 approval is required, contact Strongwell for appropriate load/deflection tables.

DURAGRID® Phenolic Technical Data

ASTM D635-77

Flammability Rate cm/min. <1

ASTM E84

Flame Spread Index 10
Smoke Index 10

UL-94

V0

EVOLUTION OF PULTRUDED GRATING

THE FRP GRATING MARKET

The pultrusion process has been responsible for the advancement and expansion of the Fiberglass Reinforced Plastic (FRP) grating market. This was not possible with other manufacturing processes. The basic needs of floor grating established the need for FRP grating. The evolution of the FRP grating market created a demand for pultruded grating. Grating made from pultruded components is able to provide the many options that the market demands.

THE FIRST GENERATION OF FRP GRATING

The first generation of FRP grating was by the hand lay-up method. It was composed of resin saturated rovings laid up in a criss-cross pattern to form a grating without the use of a mold. The advantages of this grating were that it was nonmetallic, corrosion-resistant and had a resin-rich surface. The lay-up method allowed versatility in size and strength. The disadvantages were that it was very labor intensive, it had rectangular bearing bars and low glass content which lead to high deflections and quality was poor with many voids and a rough appearance. The resin-rich surface at the corners, allowed fast surface wear and chipping. Ultraviolet deterioration was also a problem.

THE SECOND GENERATION OF FRP GRATING

The second generation of fiberglass grating is by the open mold method. The composite is composed of unidirectional glass fiber rovings and resin. This method is similar to the hand lay-up method but now a mold is used. It has the advantages of having a resin-rich surface, a better appearance and lower labor cost. The disadvantage is that a mold limits the versatility in size and strength. It has rectangular bearing bars and a low glass content which leads to high deflections and voids are a problem. It still has resin-rich surfaces at the corners which allow fast surface wear and chipping. A grit surface can be molded into the product for skid resistance but it can chip off easily. Ultraviolet deterioration can be improved only with a UV inhibitor.

THE THIRD GENERATION OF FRP GRATING

The third generation of FRP grating is by the compression molded method. This method is an improvement over the open mold method and gives a resin-rich surface. Because it is compression molded, it has a higher glass content which leads to less deflection than open molded grating. It has fewer and smaller voids and a better wearing surface. The top corners are molded and less susceptible to chipping. The disadvantage is that it is made in a mold and therefore does not offer the versatility in size and bar shape. Fiber content is not ideal and results in the need to use excessive amounts of material to achieve the desired strength and stiffness values. A skid-resistant surface must be applied as a secondary operation. Ultraviolet deterioration can be improved only with a UV inhibitor.

THE FOURTH GENERATION OF FRP GRATING

The fourth generation of FRP grating is made using pultruded components. The first pultruded FRP grating was made from an all unidirectional roving and resin composite. It had the advantages of using an engineered shape "I bar" for material savings. It had a much higher glass content (up to 70% glass) which made a much stronger part with less deflection. The pultrusion process eliminates the voids and improves quality. Because the bars can be cut to any length and located at any spacing, versatility in size and length is unlimited. The high strength of pultruded grating allows the use of the same depth as would be used with metal grating, and in most cases, without adding additional supports. The disadvantage of the first pultruded grating is that it had a less resin-rich surface and, therefore, lower corrosion resistance. Because it was made from all unidirectional rovings, it could split along the fibers. The method of assembling the bars did not provide good structural integrity, as the bars would loosen up and shift on the cross rods. The high glass content at the surface made ultraviolet deterioration a problem.

EVOLUTION OF PULTRUDED GRATING

THE FIFTH GENERATION OF FRP GRATING

Up to this point, some people believed that if you wanted a grating that had good corrosion resistance and was easy to fabricate, use molded grating. If you wanted a grating that required high strength, but lower corrosion resistance, use a pultruded grating. This line of reasoning is no longer true. Strongwell has evolved the pultruded grating design and assembling process to the point that you can now have the best of both in a variety of pultruded grating.

Each bearing bar that Strongwell manufactures is reinforced by a core of densely packed, continuous glass fibers wrapped by a continuous glass mat, plus a synthetic surfacing veil. The core of continuous glass fibers gives the longitudinal strength and stiffness. The continuous glass mat gives the bars strength in the transverse direction to protect them from chipping, cracking and lineal fracturing. This mat allows you to optimize the cross-sectional design to achieve the best stiffness and strength from the least amount of material. The synthetic surfacing veil encapsulates the bar in a 100% resin surface, which provides excellent corrosion resistance and protection from UV exposure. The average resin to glass ratio of the composite is no longer a gauge of corrosion resistance. Location and placement of the glass and resin is the real gauge of corrosion resistance.

The bearing bars are assembled into panels of grating by a unique cross-rod system. The cross-rod support system consists of two continuous, pultruded spacer bars and a center core wedge. The spacers are notched at each bearing bar so the bars are both mechanically locked and chemically bonded to the web of each bearing bar. The wedge is, in turn, bonded to the spacers to form a strong and rigid cross-rod support system that resists twist, prevents lateral movement of the bearing bars, and transfers load from one bar to the next. The cross-rod system allows the grating panels to be cut and fabricated like a solid sheet. This cross-rod system also allows unlimited selection in spacing of bearing bars.

The variety of bearing bars, along with the engineered location and placement of the reinforcements, surfacing veil and resin, gives the end user the widest product choice available. No other manufacturing process can offer the corrosion resistance or product options as economically.

PULTRUDED GRATING PANEL SIZES

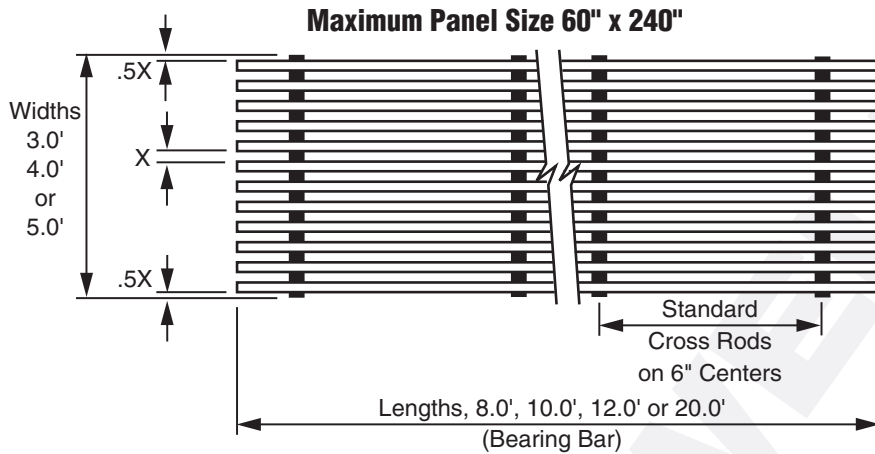

PANEL SIZE AVAILABILITY	
DURADEK®	(8" cross rod spacing)
I-6500 1" & I-6500 1-1/2"	3' x 10', 3' x 20', 4' x 8', 4' x 12', 4' x 20', 5' x 10', 5' x 20'
T-5800 2"	3' x 20', 4' x 12', 4' x 20', 5' x 10', 5' x 20'
DURAGRID®	All series available in any size and cross rod spacing (2" increments) with a maximum panel size of 5' x 20'.
DURAGRID® Phenolic	Standard panel sizes include 3' x 20', 4' x 20' Fabricated and custom size panels are also available

DURADEK® grating panels are built with bearing bars up to 240" in length and widths up to 60". Standard panel sizes are listed above. Custom grating sizes and series, other special bearing bar spacing, cross-rod spacings, oversized panels, other colors and resins are available in the line specified as **DURAGRID®**. UV coating is available on all grating series.

DURAGRID® STAIR TREADS AND LANDINGS

Stair treads and landings are produced by attaching a 2" rectangular or "box" shaped nosing to the leading edge of treads or landings. This gives added strength and rigidity to the area that takes impact and abuse. In addition, the nosing provides more surface area for skid-resistance, wear and better visibility. Exceeds O.S.H.A. Standard 1910-24.

TREAD WIDTH	COLOR	STAIR TREAD SERIES	MAXIMUM SPAN FOR 300 LBS. AT MIDSPAN	
			1/8" OR LESS DEFLECTION	1/4" OR LESS DEFLECTION
11"	Light Gray, Yellow or Earthenware (Phenolic)*	I-6000 1"	29"	37"
11"	Light Gray, Yellow or Earthenware (Phenolic)*	I-6000 1-1/2"	40"	52"
12"	Light Gray, Yellow or Earthenware (Phenolic)*	T-5000 2"	47"	59"

*Optional yellow closed nosing on light gray or phenolic panels is also available

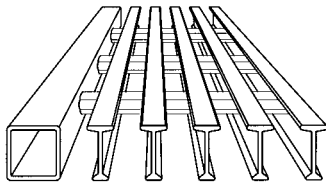

"Box" shaped nosing is used for grating with 2" depth.

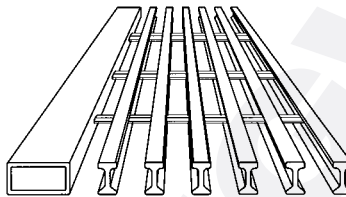

2" deep rectangular shaped nosing is used for all grating with depths of 1" and 1-1/2".

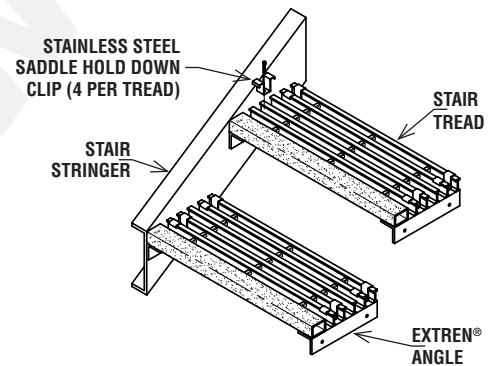

PANEL HOLD DOWNS

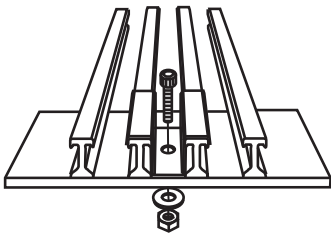

The weldable 316L stainless steel saddle clips above are available for some grating series.
*Bolts are priced separately from the saddle clips.

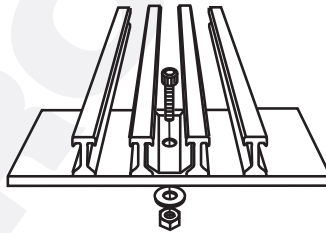

The weldable 316L stainless steel insert clips above are available for some grating series.
*Bolts are priced separately from the hold-down.

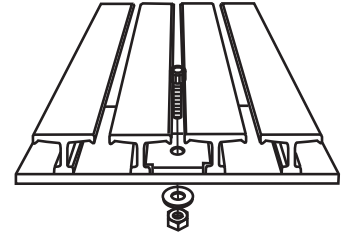

The weldable 316L stainless steel insert clips above are available for DURAGRID® T-1800 and T-3500 only.
*Bolts are priced separately from the hold-down.

(All bolts are 1/4-20 x 1-1/4", cap head, 316L stainless steel.)

PANEL CONNECTORS

Panel Connectors are generally only used at midspan to assist in transferring load from section to section.

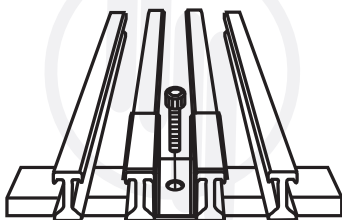

The 316L stainless steel saddle clips above are available as panel connectors for some grating series.

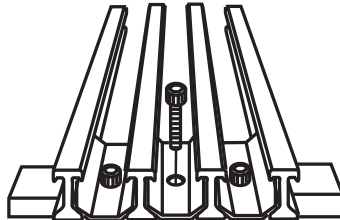

The 316L stainless steel insert clips above are available for some grating series.

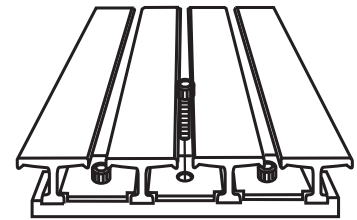

The 316L stainless steel insert clips above are available for DURAGRID® T-1800 and T-3500 only.

(All bolts are 1/4-20 x 1-1/4", cap head, 316L stainless steel.)

HOW TO SPECIFY DURADEK® GRATING

Fiberglass grating shall be DURADEK® Series (I-6500 1") (I-6500 1-½") (T-5800 2") as manufactured by Strongwell. Grating shall be pultruded and assembled in the U.S.A. Resin shall be fire retardant (polyester) (vinyl ester) meeting the requirements of a Class 1 rating of 25 or less per ASTM E-84 and the self-extinguishing requirements of ASTM D-635. Bearing bar color shall be (light gray) (yellow). Resin shall be UV inhibited and the composite shall include a veil on all exposed surfaces. Panels shall be assembled into the sizes ordered using a 3-piece pultruded cross-rod system with color correlating with chosen resin system: polyester = light gray, vinyl ester = black.

The cross-rods shall consist of a center core wedge and two spacer bars that are notched at each bearing bar so that each bearing bar is both mechanically locked and chemically bonded to the web of each bearing bar. The spacer bars shall be continually bonded to the center core wedge. The cross-rods shall be spaced a maximum of 8" in the panel. The top of the panels shall be covered with a bonded epoxy medium grit anti-skid surface.

NOTE: If special options are required that are not stated in the above specification, fill in your special requirement in the appropriate section.

NOTE: See Section 20 — **STRONGWELL SPECIFICATIONS FOR FIBERGLASS REINFORCED POLYMER PRODUCTS AND FABRICATIONS.**

HOW TO ORDER DURADEK® GRATING

When ordering DURADEK®, ensure the bearing bars for installation will be oriented in the correct direction for the application. Bearing bars shall traverse from support to support. Cross-rods are not intended to be applied in the span direction. The adjacent drawing will help specify the width and length of panels.

Panel Sizes Are Specified: Width x Length

NOTE: DURAGRID®, Strongwell's line of custom pultruded grating, is available with a wide array of options, including: colors, resin systems, panel sizes, cross rod spacings and more.

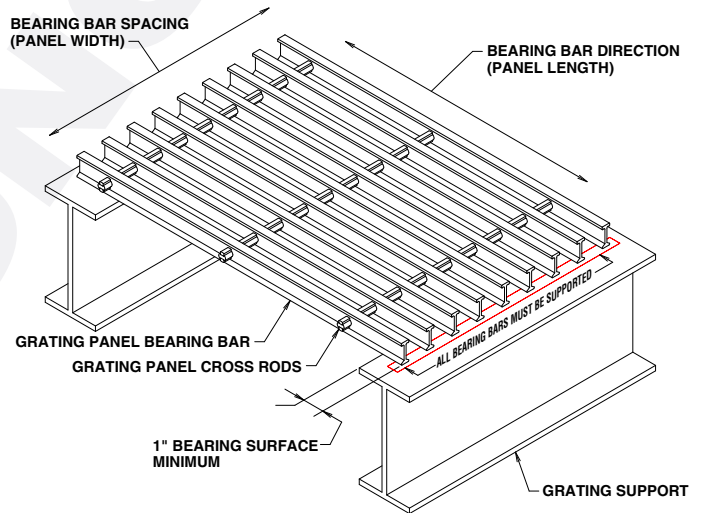

DURADEK® GRATING SERIES

SERIES	BEARING BAR THICKNESS	NO. BARS PER FT. WIDTH	BEARING BAR CENTER	OPEN SPACE	OPEN AREA	APPROX. WEIGHT PER FT ²	SPAN*	CROSS-SECTIONAL AREA (PER FT. OF WIDTH)	MOMENT OF INERTIA (PER FT. OF WIDTH)	SECTION MODULUS (PER FT. OF WIDTH)
I-6500	1.0"	7	1.71"	1.11"	65%	2.2 lb	42"	2.190 in ²	0.288 in ⁴	0.575 in ³
I-6500	1.5"	7	1.71"	1.11"	65%	2.7 lb	54"	2.752 in ²	0.814 in ⁴	1.088 in ³
T-5800	2.0"	5	2.40"	1.40"	58%	2.6 lb	62"	2.711 in ²	1.396 in ⁴	top: 1.588 in ³ bottom: 1.247 in ³

*NOTE: When a 100 lb per square foot uniform load is placed upon a simple span of this dimension, it will produce a deflection of 1/4" at midspan.

DURADEK® GRATING UNIFORM LOAD / DEFLECTION

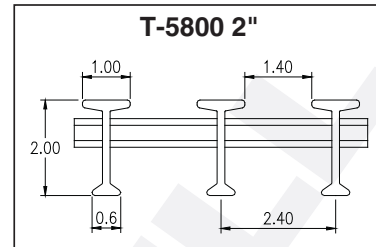
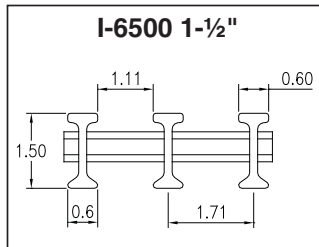
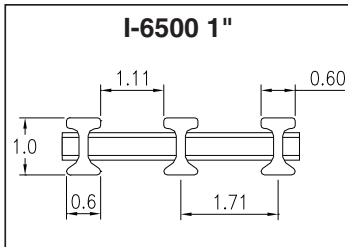

LOAD in LB / SQUARE FOOT (PSF)

SPAN INCHES	STYLE		LOAD (PSF)																MAXIMUM RECOMMENDED LOAD (PSF)	DEFLECTION	E X 10 ⁶ PSI
	SERIES	DEPTH	50	100	150	200	250	300	400	500	750	1000	2000	3000	4000	5000	6000				
12	I-6500	1"	<0.01	<0.01	<0.01	<0.01	0.01	0.01	0.01	0.01	0.02	0.02	0.04	0.06	0.08			9123	0.19	3.78	
	I-6500	1-½"	<0.01	<0.01	<0.01	<0.01	<0.01	<0.01	<0.01	<0.01	0.01	0.01	0.02	0.02	0.03	0.04	0.04	15439	0.11	3.79	
	T-5800	2"	<0.01	<0.01	<0.01	<0.01	<0.01	<0.01	<0.01	<0.01	<0.01	<0.01	<0.01	0.01	0.01	0.02		9444	0.04	3.80	
18	I-6500	1"	0.01	0.01	0.01	0.02	0.02	0.03	0.04	0.05	0.07	0.10	0.19	0.29	0.38			4346	0.41	4.15	
	I-6500	1-½"	<0.01	<0.01	0.01	0.01	0.01	0.01	0.01	0.02	0.03	0.04	0.07	0.10	0.14	0.17	0.21	6862	0.24	4.05	
	T-5800	2"	<0.01	<0.01	<0.01	<0.01	0.01	0.01	0.01	0.01	0.02	0.02	0.04	0.06	0.08			6280	0.13	3.91	
24	I-6500	1"	0.01	0.03	0.04	0.06	0.07	0.09	0.11	0.14	0.21	0.28	0.57					2544	0.72	4.41	
	I-6500	1-½"	0.01	0.01	0.02	0.02	0.03	0.03	0.04	0.05	0.08	0.10	0.21	0.31				3860	0.40	4.24	
	T-5800	2"	<0.01	0.01	0.01	0.01	0.02	0.02	0.03	0.03	0.05	0.06	0.13	0.19	0.25			4722	0.30	4.01	
30	I-6500	1"	0.03	0.07	0.10	0.13	0.17	0.20	0.26	0.33	0.49	0.66						1628	1.07	4.63	
	I-6500	1-½"	0.01	0.03	0.04	0.05	0.06	0.07	0.10	0.12	0.18	0.25	0.49					2433	0.60	4.40	
	T-5800	2"	0.01	0.02	0.02	0.03	0.04	0.05	0.06	0.08	0.11	0.15	0.30	0.45				3022	0.45	4.10	
36	I-6500	1"	0.07	0.13	0.20	0.26	0.33	0.39	0.52	0.66								1130	1.48	4.83	
	I-6500	1-½"	0.03	0.05	0.08	0.10	0.12	0.15	0.20	0.25	0.37	0.50						1663	0.83	4.50	
	T-5800	2"	0.02	0.03	0.05	0.06	0.08	0.09	0.12	0.15	0.23	0.30	0.61					2099	0.64	4.18	
42	I-6500	1"	0.12	0.24	0.36	0.48	0.60											827	1.99	4.88	
	I-6500	1-½"	0.05	0.09	0.14	0.18	0.23	0.27	0.36	0.45	0.68							1194	1.08	4.59	
	T-5800	2"	0.03	0.06	0.08	0.11	0.14	0.17	0.22	0.28	0.42	0.55						1542	0.85	4.25	
48	I-6500	1"	0.20	0.40	0.60													630	2.53	4.98	
	I-6500	1-½"	0.08	0.15	0.23	0.30	0.38	0.46	0.61									892	1.35	4.66	
	T-5800	2"	0.05	0.09	0.14	0.19	0.23	0.28	0.37	0.46								1181	1.09	4.34	
54	I-6500	1"	0.32	0.64														496	3.18	5.00	
	I-6500	1-½"	0.12	0.24	0.36	0.48	0.60											681	1.64	4.71	
	T-5800	2"	0.07	0.15	0.22	0.29	0.36	0.44	0.58									933	1.36	4.41	
60	I-6500	1-½"	0.18	0.36	0.55													533	1.94	4.74	
	T-5800	2"	0.11	0.22	0.33	0.44	0.55	0.66										756	1.66	4.47	
66	I-6500	1-½"	0.27	0.53														425	2.26	4.76	
	T-5800	2"	0.16	0.32	0.48	0.63												624	1.98	4.52	
72	T-5800	2"	0.22	0.44	0.67													524	2.33	4.58	
78	T-5800	2"	0.30	0.61														447	2.71	4.61	

NOTE: The black area () indicates where the load produces ≤ 0.25" deflection.

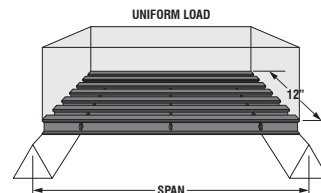

DURADEK® GRATING CONCENTRATED LOAD / DEFLECTION

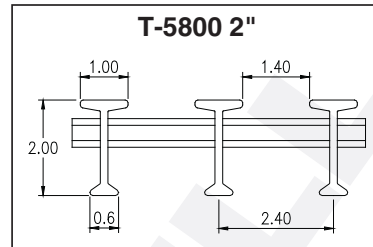
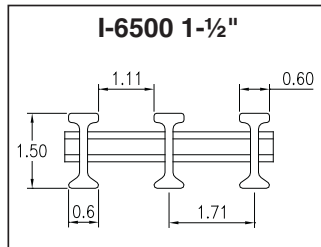
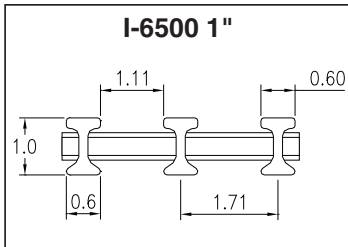

LOAD in LB / FOOT of WIDTH

SPAN INCHES	STYLE																MAXIMUM RECOM-MENDED LOAD (PSF)	DEFLEC-TION	E X 10 ⁶ PSI	
	SERIES	DEPTH	50	100	150	200	250	300	400	500	750	1000	2000	3000	4000	5000				6000
12	I-6500	1"	<0.01	<0.01	0.01	0.01	0.01	0.01	0.01	0.02	0.03	0.03	0.07	0.10	0.13	4561	0.15	3.78		
	I-6500	1-½"	<0.01	<0.01	<0.01	<0.01	<0.01	<0.01	0.01	0.01	0.01	0.01	0.02	0.04	0.05	0.06	0.07	7719	0.09	3.79
	T-5800	2"	<0.01	<0.01	<0.01	<0.01	<0.01	<0.01	<0.01	<0.01	0.01	0.01	0.01	0.01	0.02	0.03	4722	0.03	3.80	
18	I-6500	1"	0.01	0.01	0.02	0.02	0.03	0.03	0.04	0.05	0.08	0.10	0.20	0.31	3259	0.33	4.15			
	I-6500	1-½"	<0.01	<0.01	0.01	0.01	0.01	0.01	0.02	0.02	0.03	0.04	0.07	0.11	0.15	0.18	5146	0.19	4.05	
	T-5800	2"	<0.01	<0.01	<0.01	<0.01	0.01	0.01	0.01	0.01	0.02	0.02	0.04	0.07	0.09	4722	0.10	3.91		
24	I-6500	1"	0.01	0.02	0.03	0.05	0.06	0.07	0.09	0.11	0.17	0.23	0.45	2544	0.58	4.41				
	I-6500	1-½"	0.01	0.01	0.01	0.02	0.02	0.03	0.03	0.04	0.06	0.08	0.17	0.25	3860	0.32	4.24			
	T-5800	2"	<0.01	0.01	0.01	0.01	0.01	0.02	0.02	0.03	0.04	0.05	0.10	0.15	0.20	4722	0.24	4.01		
30	I-6500	1"	0.02	0.04	0.06	0.08	0.11	0.13	0.17	0.21	0.32	0.42	2035	0.86	4.63					
	I-6500	1-½"	0.01	0.02	0.02	0.03	0.04	0.05	0.06	0.08	0.12	0.16	0.31	0.47	3041	0.48	4.40			
	T-5800	2"	0.01	0.01	0.01	0.02	0.02	0.03	0.04	0.05	0.07	0.10	0.19	0.29	3778	0.36	4.10			
36	I-6500	1"	0.04	0.07	0.11	0.14	0.18	0.21	0.28	0.35	0.52	1696	1.19	4.83						
	I-6500	1-½"	0.01	0.03	0.04	0.05	0.07	0.08	0.11	0.13	0.20	0.27	0.53	2495	0.66	4.50				
	T-5800	2"	0.01	0.02	0.02	0.03	0.04	0.05	0.07	0.08	0.12	0.16	0.32	0.49	3148	0.51	4.18			
42	I-6500	1"	0.06	0.11	0.17	0.22	0.28	0.33	0.44	0.55	1447	1.59	4.88							
	I-6500	1-½"	0.02	0.04	0.06	0.08	0.10	0.12	0.17	0.21	0.31	0.41	2088	0.86	4.59					
	T-5800	2"	0.01	0.03	0.04	0.05	0.06	0.08	0.10	0.13	0.19	0.25	0.51	2698	0.68	4.25				
48	I-6500	1"	0.08	0.16	0.24	0.32	0.40	0.48	0.64	1260	2.02	4.98								
	I-6500	1-½"	0.03	0.06	0.09	0.12	0.15	0.18	0.24	0.30	0.46	0.61	1784	1.08	4.66					
	T-5800	2"	0.02	0.04	0.06	0.07	0.09	0.11	0.15	0.19	0.28	0.37	2361	0.87	4.34					
54	I-6500	1"	0.11	0.23	0.34	0.46	0.57	0.68	1117	2.55	5.00									
	I-6500	1-½"	0.04	0.09	0.13	0.17	0.21	0.26	0.34	0.43	0.64	1533	1.31	4.71						
	T-5800	2"	0.03	0.05	0.08	0.10	0.13	0.16	0.21	0.26	0.39	0.52	2099	1.09	4.41					
60	I-6500	1-½"	0.06	0.12	0.18	0.23	0.30	0.35	0.47	0.58	1333	1.56	4.74							
	T-5800	2"	0.04	0.07	0.11	0.14	0.18	0.21	0.28	0.35	0.53	1889	1.32	4.47						
66	I-6500	1-½"	0.08	0.16	0.23	0.31	0.39	0.46	0.62	1170	1.81	4.76								
	T-5800	2"	0.05	0.09	0.14	0.19	0.23	0.28	0.37	0.46	1717	1.58	4.52							
72	T-5800	2"	0.06	0.12	0.18	0.24	0.30	0.36	0.47	0.59	1574	1.86	4.58							
78	T-5800	2"	0.08	0.15	0.22	0.30	0.37	0.45	0.60	1453	2.17	4.61								

NOTE: The black area (**0.23**) indicates where the load produces ≤ 0.25" deflection.

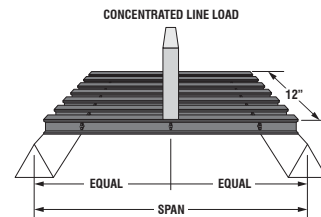

HOW TO SPECIFY DURAGRID® GRATING

Fiberglass grating shall be DURAGRID® Series (_____) as manufactured by Strongwell. Grating shall be pultruded and assembled in the U.S.A. Resin shall be fire retardant (_____) meeting the requirements of a Class 1 rating of 25 or less per ASTM E-84 and the self-extinguishing requirements of ASTM D-635. Bearing bar color shall be (_____). Resin shall be UV inhibited and the composite shall include a veil on all exposed surfaces. Panels shall be assembled into the sizes ordered using a 3-piece pultruded cross-rod system with color correlating with chosen resin system: polyester = light gray, vinyl ester = black.

The cross-roads shall consist of a center core wedge and two spacer bars that are notched at each bearing bar so that each bearing bar is both mechanically locked and chemically bonded to the web of each bearing bar. The spacer bars shall be continually bonded to the center core wedge. The cross-roads shall be spaced a maximum of (____)\" in the panel. The top of the panels (shall) (shall not) be covered with a bonded grit anti-skid surface.

NOTE: If special options are required that are not stated in the above specification, fill in your special requirement in the appropriate section.

NOTE: See Section 20 — **STRONGWELL SPECIFICATIONS FOR FIBERGLASS REINFORCED POLYMER PRODUCTS AND FABRICATIONS.**

HOW TO ORDER DURAGRID® GRATING

When ordering DURAGRID®, ensure the bearing bars for installation will be oriented in the correct direction for the application. Bearing bars shall traverse from support to support. Cross-roads are not intended to be applied in the span direction. The adjacent drawing will help specify the width and length of panels.

NOTE: Width is the measurement from end to end of the cross-roads. Length is always the bearing bar length.

Panel Sizes Are Specified: Width x Length

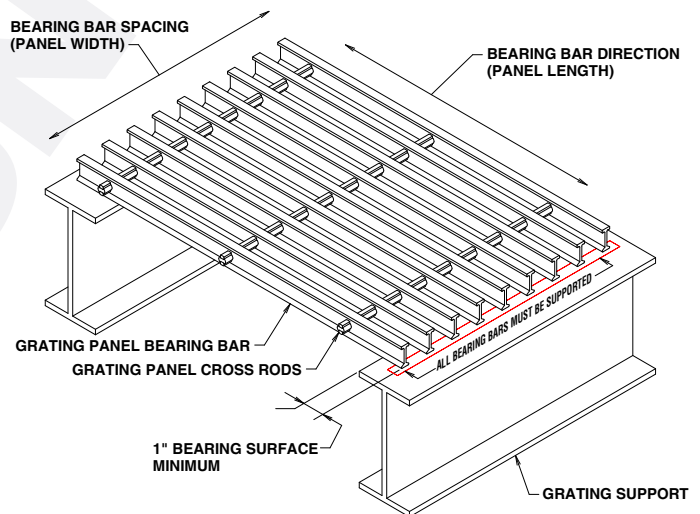

DURAGRID® I-BAR PULTRUDED GRATING

NOTES: ¹ 100 psf load, simple span (dimensions shown), 0.25" deflection.
² Weight per square foot is based upon cross rods 6" on center. Deduct 0.186 lbs/ft² for 12" on center.
 N/A : Not intended for pedestrian applications. For full load tables, visit <http://www.strongwell.com/gratingloadtables>

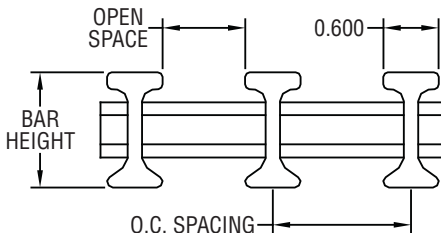
SERIES	ON CENTER SPACING	OPEN SPACE	# BARS PER FOOT OF WIDTH	% OPEN SPACE	BAR HEIGHT	SPAN ¹	WT/FT ²	FIGURE
I-2000	0.750	0.150	16	20%	1.00"	52	4.5	
					1.25"	58	5.0	
					1.50"	67	5.5	
I-3000	0.850	0.250	14.12	30%	1.00"	51	4.0	
					1.25"	56	4.5	
					1.50"	65	4.9	
I-4000	1.000	0.400	12	40%	1.00"	48	3.4	
					1.25"	54	3.9	
					1.50"	62	4.2	
I-4800	1.161	0.561	10.33	48%	1.00"	47	3.0	
					1.50"	60	3.8	
I-5000	1.200	0.600	10	50%	1.00"	46	2.9	
					1.25"	52	3.3	
					1.50"	59	3.6	
I-5500	1.330	0.730	9.02	55%	1.00"	45	2.7	
					1.50"	58	3.2	
I-6000	1.500	0.900	8	60%	1.00"	44	2.4	
					1.25"	49	2.7	
					1.50"	56	3.0	
I-6500	1.710	1.110	7.02	65%	1.00"	42	2.2	
					1.25"	47	2.4	
					1.50"	54	2.7	
I-7000	2.000	1.400	6	70%	1.00"	40	1.9	
					1.25"	45	2.1	
					1.50"	52	2.3	
I-7500	2.400	1.800	5	75%	1.00"	N/A	1.7	
					1.25"	N/A	1.8	
					1.50"	N/A	2.0	
I-8000	3.000	2.400	4	80%	1.00"	N/A	1.4	
					1.25"	N/A	1.5	
					1.50"	N/A	1.7	
I-8300	3.600	3.000	3.33	83%	1.00"	N/A	1.3	
					1.25"	N/A	1.3	
					1.50"	N/A	1.4	
I-8500	4.000	3.400	3	85%	1.00"	N/A	1.2	
					1.25"	N/A	1.2	
					1.50"	N/A	1.3	
I-9000	6.000	5.400	2	90%	1.00"	N/A	0.9	
					1.25"	N/A	1.0	
					1.50"	N/A	1.0	

DURAGRID® T-BAR PULTRUDED GRATING

¹ 100 psf load, simple span (dimensions shown), 0.25" deflection.

NOTES: ² Weight per square foot is based upon cross rods 6" on center. Deduct 0.186 lbs/ft² for 12" on center.

N/A : Not intended for pedestrian applications. For full load tables, visit <http://www.strongwell.com/gratingloadtables>

SERIES	ON CENTER SPACING	OPEN SPACE	# BARS PER FOOT OF WIDTH	% OPEN SPACE	BAR HEIGHT	SPAN ¹	WT/FT ²	FIGURE
ET-3300	1.500"	0.500"	8	33%	1.00"	39	2.0	
					1.50"	48	2.4	
ET-5000	2.000"	1.000"	6	50%	1.00"	36	1.6	
					1.50"	45	1.9	
ET-7200	2.600"	1.600"	3.33	72%	1.00"	31	0.9	
					1.50"	38	1.1	
ET-8300	6.000"	5.000"	2	83%	1.00"	N/A	0.8	
ET-8800	8.000"	7.000"	1.71	88%	1.00"	N/A	0.7	
T-0000	1.625"	0.000"	7.38	0%	1.00"	44	3.1	
T-1000	1.800"	0.175"	6.67	10%	1.00"	43	2.9	
T-1200	1.850"	0.225"	6.49	12%	1.00"	43	2.8	
T-1800	2.000"	0.375"	6	18%	1.00"	42	2.6	
T-2500	2.120"	0.495"	5.66	25%	1.00"	42	2.5	
T-3000	2.330"	0.705"	5.15	30%	1.00"	41	2.4	
T-3500	2.400"	0.775"	5	35%	1.00"	40	2.3	
T-3800	2.620"	0.995"	4.58	38%	1.00"	39	2.1	
T-0000	1.625"	0.000"	7.38	0%	1.50"	58	3.8	
T-1000	1.800"	0.175"	6.67	10%	1.50"	57	3.5	
T-1200	1.850"	0.225"	6.49	12%	1.50"	56	3.4	
T-1800	2.000"	0.375"	6	18%	1.50"	55	3.2	
T-2500	2.120"	0.495"	5.66	25%	1.50"	54	3.0	
T-3500	2.400"	0.775"	5	35%	1.50"	53	2.7	
T-3800	2.620"	0.995"	4.58	38%	1.50"	52	2.5	
T-0000	1.000"	0.000"	12	0%	2.00"	78	5.7	
T-1700	1.200"	0.200"	10	17%	2.00"	74	4.8	
T-3300	1.500"	0.500"	8	33%	2.00"	70	3.9	
T-5000	2.000"	1.000"	6	50%	2.00"	65	3.1	
T-5800	2.400"	1.400"	5	58%	2.00"	62	2.6	
T-6700	3.000"	2.000"	4	67%	2.00"	58	2.2	

DURAGRID® HD PULTRUDED GRATING

NOTES: ¹ 100 psf load, simple span (dimensions shown), 0.25" deflection.
² Weight per square foot is based upon cross rods 6" on center. Deduct 0.186 lbs/ft² for 12" on center.
 HD Grating is generally suitable for long spans or heavy wheel loads. For full load tables, visit <http://www.strongwell.com/gratingloadtables>

SERIES	ON CENTER SPACING	OPEN SPACE	# BARS PER FOOT OF WIDTH	% OPEN SPACE	BAR HEIGHT	SPAN ¹	WT/FT ²	FIGURE
HD-3000	0.850"	0.250"	14	30%	1.00"	56	7.8	
					1.25"	66	9.5	
					1.50"	75	11.3	
					1.75"	85	13.0	
					2.00"	93	16.1	
					2.25"	102	17.1	
					2.50"	110	18.2	
HD-4000	1.000"	0.400"	12	40%	1.00"	54	7.0	
					1.25"	63	8.5	
					1.50"	72	10.1	
					1.75"	82	11.6	
					2.00"	89	14.4	
					2.25"	98	14.7	
HD-5000	1.200"	0.600"	10	50%	1.00"	51	5.9	
					1.25"	61	7.2	
					1.50"	68	8.5	
					1.75"	78	9.8	
					2.00"	85	11.1	
					2.25"	94	12.4	
					2.50"	101	13.7	
HD-6000	1.500"	0.900"	8	60%	1.00"	48	4.9	
					1.25"	57	5.9	
					1.50"	65	7.0	
					1.75"	73	8.0	
					2.00"	80	9.0	
					2.25"	89	10.1	
					2.50"	95	11.1	

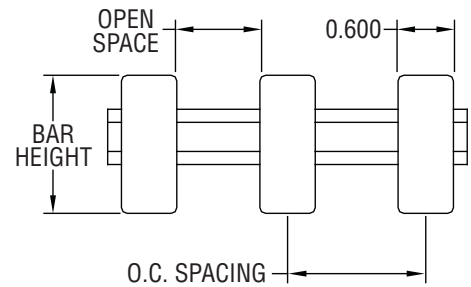

DURAGRID® R-BAR PULTRUDED GRATING

NOTES: ¹ 100 psf load, simple span (dimensions shown), 0.25" deflection.
² Weight per square foot is based upon cross rods 6" on center. Deduct 0.186 lbs/ft² for 12" on center.
 N/A : Not intended for pedestrian applications. For full load tables, visit <http://www.strongwell.com/gratingloadtables>

SERIES	ON CENTER SPACING	OPEN SPACE	# BARS PER FOOT OF WIDTH	% OPEN SPACE	BAR HEIGHT	SPAN ¹	WT/FT ²	FIGURE
R-6200	0.813"	0.500"	14.77	62%	1.00"	46	4.5	<p>The diagram illustrates the cross-section of the pultruded grating. It shows three parallel bars with a consistent height. The distance between the centers of two adjacent bars is labeled 'O.C. SPACING'. The distance between the inner edges of two adjacent bars is labeled 'OPEN SPACE'. The height of the bars is labeled 'BAR HEIGHT'. A specific dimension of 0.3125 is indicated for the width of the bars.</p>
R-7300	1.188"	0.875"	10.1	73%	1.00"	42	3.2	
R-8300	1.875"	1.563"	6.4	83%	1.00"	37	2.2	
R-9000	3.000"	2.688"	4	90%	1.00"	N/A	1.4	
R-9500	6.000"	5.688"	2	95%	1.00"	N/A	0.7	
R-9700	11.875"	11.563"	1	97%	1.00"	N/A	0.4	

HOW TO SPECIFY DURAGRID® PHENOLIC GRATING

Fiberglass grating shall be DURAGRID® Phenolic Series (_____) as manufactured by Strongwell. Grating shall be pultruded using phenolic resin and assembled in the U.S.A. The grating shall have a current Level 2 USCG Type Approval to ASTM F3059-15¹ and meet the smoke and toxicity requirements of Annex 1 (resolution MSC.307 (88)), Part 2, 2.41 and 2.42 of the FTP Code as issued by the International Maritime Organization (IMO).

Panels shall be assembled into the sizes ordered using a 3-piece pultruded cross-rod system.

The cross-rods shall consist of a center core wedge and two spacer bars that are notched at each bearing bar so that each bearing bar is both mechanically locked and chemically bonded to the web of each bearing bar. The spacer bars shall be continually bonded to the center core wedge. The cross-rods shall be spaced a maximum of 6" in the panel. The top of the panels (shall) (shall not) be covered with a bonded grit anti-skid surface. Color shall be earthenware brown (RAL 8023) signifying Fire Integrity.

¹ASTM F3059 includes requirements for structural fire integrity, durability, (impact and wheel loads) and ASTM tests: B117, D2047, D4060, D4329, E84, E119, E695.

NOTE: If special options are required that are not stated in the above specification, fill in your special requirement in the appropriate section.

NOTE: See Section 20 — **STRONGWELL SPECIFICATIONS FOR FIBERGLASS REINFORCED POLYMER PRODUCTS AND FABRICATIONS.**

HOW TO ORDER DURAGRID® PHENOLIC GRATING

When ordering DURAGRID® Phenolic, ensure the bearing bars for installation will be oriented in the correct direction for the application. Bearing bars shall traverse from support to support. Cross-rods are not intended to be applied in the span direction. The adjacent drawing will help specify the width and length of panels.

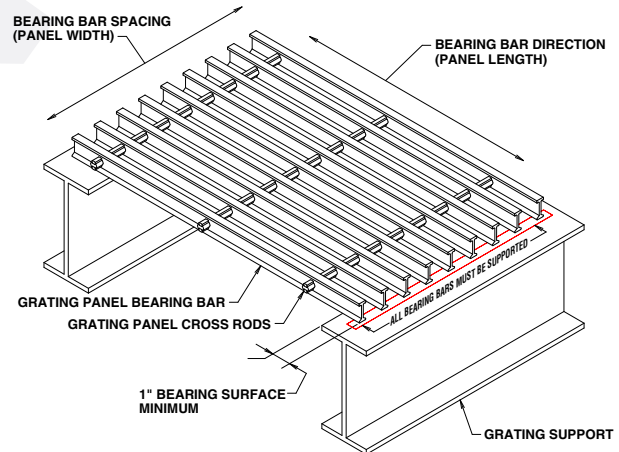

NOTE: Width is the measurement from end to end of the cross-rods. Length is always the bearing bar length.

Panel Sizes Are Specified: Width x Length

DURAGRID® PHENOLIC GRATING SERIES (MOST POPULAR)

SERIES	BEARING BAR THICKNESS	OPEN AREA	APPROX. WEIGHT LB/FT ²	A (PER FT OF WIDTH)	I (PER FT OF WIDTH)	S (PER FT OF WIDTH)	UNIFORM LOAD* LB/FT ²	CONCENTRATED LOAD** LB/FT
I-6000	1-1/2"	60%	3.4	3.11 in ²	0.88 in ⁴	1.18 in ³	350	800
I-5500	1-1/2"	55%	3.9	3.51 in ²	0.99 in ⁴	1.32 in ³	390	900
I-4800	1-1/2"	48%	4.4	4.02 in ²	1.14 in ⁴	1.52 in ³	450	1030
I-4000	1-1/2"	40%	5.2	4.67 in ²	1.32 in ⁴	1.76 in ³	525	1200
I-6000	1-3/4"	60%	3.9	3.78 in ²	1.48 in ⁴	1.57 in ³	585	1340
I-5500	1-3/4"	55%	4.4	4.25 in ²	1.67 in ⁴	1.77 in ³	660	1510
I-4800	1-3/4"	48%	5.0	4.88 in ²	1.91 in ⁴	2.03 in ³	755	1730
I-4000	1-3/4"	40%	5.9	5.66 in ²	2.22 in ⁴	2.36 in ³	875	2010

* Uniform load based on a qualified span of 44" to produce a deflection of 0.25" at midspan.
 ** Concentrated load based on a qualified span of 44" to produce a deflection of 0.25" at midspan.

DURAGRID® PHENOLIC GRATING UNIFORM LOAD / DEFLECTION

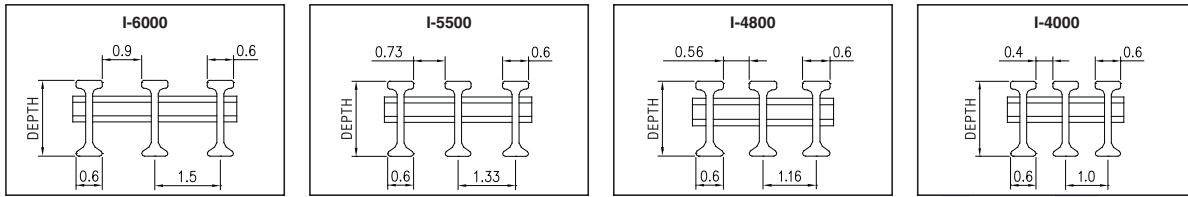

LOAD in LB / SQUARE FOOT (PSF)

SPAN INCHES	STYLE		LOAD in LB / SQUARE FOOT (PSF)														SAFE LOAD, 2:1 SAFETY FACTOR	DEFLECTION	E X 10 ⁶ PSI	
	SERIES	DEPTH	50	100	150	200	250	300	400	500	750	1000	2000	3000	4000	5000				6000
24	I-6000	1-1/2"	<0.01	0.01	0.01	0.02	0.02	0.02	0.03	0.04	0.06	0.08	0.15	0.23	0.31	0.38		5388	0.41	5.31
	I-5500	1-1/2"	<0.01	0.01	0.01	0.01	0.02	0.02	0.03	0.03	0.05	0.07	0.14	0.21	0.27	0.34	0.41	6062	0.41	5.31
	I-4800	1-1/2"	<0.01	0.01	0.01	0.01	0.01	0.02	0.02	0.03	0.04	0.06	0.12	0.18	0.24	0.30	0.36	6964	0.41	5.31
	I-4000	1-1/2"	<0.01	0.01	0.01	0.01	0.01	0.02	0.02	0.03	0.04	0.05	0.10	0.15	0.21	0.26	0.31	8082	0.41	5.31
	I-6000	1-3/4"	<0.01	<0.01	0.01	0.01	0.01	0.01	0.02	0.02	0.03	0.05	0.09	0.14	0.18	0.23	0.27	7206	0.33	5.31
	I-5500	1-3/4"	<0.01	<0.01	0.01	0.01	0.01	0.01	0.02	0.02	0.03	0.04	0.08	0.12	0.16	0.20	0.24	8107	0.33	5.31
	I-4800	1-3/4"	<0.01	<0.01	0.01	0.01	0.01	0.01	0.01	0.02	0.03	0.04	0.07	0.11	0.14	0.18	0.21	9314	0.33	5.31
	I-4000	1-3/4"	<0.01	<0.01	<0.01	0.01	0.01	0.01	0.01	0.02	0.02	0.03	0.06	0.09	0.12	0.15	0.18	10809	0.33	5.31
30	I-6000	1-1/2"	0.01	0.02	0.03	0.04	0.04	0.05	0.07	0.09	0.13	0.18	0.36	0.53				3761	0.67	5.60
	I-5500	1-1/2"	0.01	0.02	0.02	0.03	0.04	0.05	0.06	0.08	0.12	0.16	0.32	0.47	0.63			4231	0.67	5.60
	I-4800	1-1/2"	0.01	0.01	0.02	0.03	0.03	0.04	0.06	0.07	0.10	0.14	0.28	0.41	0.55			4861	0.67	5.60
	I-4000	1-1/2"	0.01	0.01	0.02	0.02	0.03	0.04	0.05	0.06	0.09	0.12	0.24	0.36	0.47	0.59		5642	0.67	5.60
	I-6000	1-3/4"	0.01	0.01	0.02	0.02	0.03	0.03	0.04	0.05	0.08	0.11	0.21	0.32	0.42	0.53		5031	0.53	5.60
	I-5500	1-3/4"	<0.01	0.01	0.01	0.02	0.02	0.03	0.04	0.05	0.07	0.09	0.19	0.28	0.38	0.47		5660	0.53	5.60
	I-4800	1-3/4"	<0.01	0.01	0.01	0.02	0.02	0.02	0.03	0.04	0.06	0.08	0.16	0.25	0.33	0.41	0.49	6503	0.53	5.60
	I-4000	1-3/4"	<0.01	0.01	0.01	0.01	0.02	0.02	0.03	0.04	0.05	0.07	0.14	0.21	0.28	0.35	0.42	7547	0.53	5.60
36	I-6000	1-1/2"	0.02	0.03	0.05	0.07	0.09	0.10	0.14	0.17	0.26	0.34						2612	0.90	6.00
	I-5500	1-1/2"	0.02	0.03	0.05	0.06	0.08	0.09	0.12	0.15	0.23	0.31	0.61					2939	0.90	6.00
	I-4800	1-1/2"	0.01	0.03	0.04	0.05	0.07	0.08	0.11	0.13	0.20	0.27	0.53					3376	0.90	6.00
	I-4000	1-1/2"	0.01	0.02	0.03	0.05	0.06	0.07	0.09	0.11	0.17	0.23	0.46					3918	0.90	6.00
	I-6000	1-3/4"	0.01	0.02	0.03	0.04	0.05	0.06	0.08	0.10	0.15	0.21	0.41	0.62				3494	0.72	6.00
	I-5500	1-3/4"	0.01	0.02	0.03	0.04	0.05	0.05	0.07	0.09	0.14	0.18	0.36	0.55				3931	0.72	6.00
	I-4800	1-3/4"	0.01	0.02	0.02	0.03	0.04	0.05	0.06	0.08	0.12	0.16	0.32	0.48	0.64			4516	0.72	6.00
	I-4000	1-3/4"	0.01	0.01	0.02	0.03	0.03	0.04	0.05	0.07	0.10	0.14	0.27	0.41	0.55			5241	0.72	6.00
42	I-6000	1-1/2"	0.03	0.06	0.09	0.12	0.15	0.18	0.24	0.30	0.45	0.60						1919	1.16	6.34
	I-5500	1-1/2"	0.03	0.05	0.08	0.11	0.13	0.16	0.21	0.27	0.40	0.54						2159	1.16	6.34
	I-4800	1-1/2"	0.02	0.05	0.07	0.09	0.12	0.14	0.19	0.23	0.35	0.47						2480	1.16	6.34
	I-4000	1-1/2"	0.02	0.04	0.06	0.08	0.10	0.12	0.16	0.20	0.30	0.40						2879	1.16	6.34
	I-6000	1-3/4"	0.02	0.04	0.05	0.07	0.09	0.11	0.14	0.18	0.27	0.36						2567	0.92	6.34
	I-5500	1-3/4"	0.02	0.03	0.05	0.06	0.08	0.10	0.13	0.16	0.24	0.32						2888	0.92	6.34
	I-4800	1-3/4"	0.01	0.03	0.04	0.06	0.07	0.08	0.11	0.14	0.21	0.28	0.56					3318	0.92	6.34
	I-4000	1-3/4"	0.01	0.02	0.04	0.05	0.06	0.07	0.10	0.12	0.18	0.24	0.48					3851	0.92	6.34

NOTE: The black area () indicates at what point the load weight has ≤ 0.25" deflection.
NOTE: These tables represent the most popular series of DURAGRID® Phenolic.
For all other series and sizes, contact your Strongwell representative.

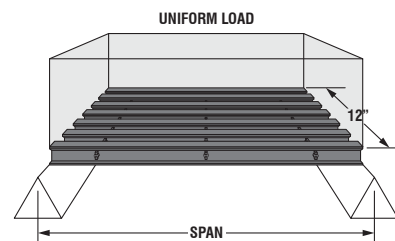

DURAGRID® PHENOLIC GRATING UNIFORM LOAD / DEFLECTION

SPAN INCHES	STYLE		50	100	150	200	250	300	400	500	750	1000	2000	3000	4000	5000	6000	SAFE LOAD, 2:1 SAFETY FACTOR	DEFLEC- TION	E X 10 ⁶ PSI	
	SERIES	DEPTH																			
48	I-6000	1-1/2"	0.05	0.10	0.15	0.20	0.25	0.30	0.40	0.49								1469	1.45	6.60	
	I-5500	1-1/2"	0.04	0.09	0.13	0.18	0.22	0.26	0.35	0.44								1653	1.45	6.60	
	I-4800	1-1/2"	0.04	0.08	0.11	0.15	0.19	0.23	0.31	0.38	0.57							1899	1.45	6.60	
	I-4000	1-1/2"	0.03	0.07	0.10	0.13	0.16	0.20	0.26	0.33	0.49							2204	1.45	6.60	
	I-6000	1-3/4"	0.03	0.06	0.09	0.12	0.15	0.18	0.24	0.29	0.44	0.59							1965	1.16	6.60
	I-5500	1-3/4"	0.03	0.05	0.08	0.10	0.13	0.16	0.21	0.26	0.39	0.52							2211	1.16	6.60
	I-4800	1-3/4"	0.02	0.05	0.07	0.09	0.11	0.14	0.18	0.23	0.34	0.46							2540	1.16	6.60
	I-4000	1-3/4"	0.02	0.04	0.06	0.08	0.10	0.12	0.16	0.20	0.29	0.39							2948	1.16	6.60
54	I-6000	1-1/2"	0.08	0.16	0.23	0.31	0.39	0.47	0.62										1161	1.81	6.70
	I-5500	1-1/2"	0.07	0.14	0.21	0.28	0.35	0.42	0.56										1306	1.81	6.70
	I-4800	1-1/2"	0.06	0.12	0.18	0.24	0.30	0.36	0.48	0.60									1501	1.81	6.70
	I-4000	1-1/2"	0.05	0.10	0.16	0.21	0.26	0.31	0.42	0.52									1742	1.81	6.70
	I-6000	1-3/4"	0.05	0.09	0.14	0.19	0.23	0.28	0.37	0.47									1553	1.45	6.70
	I-5500	1-3/4"	0.04	0.08	0.12	0.17	0.21	0.25	0.33	0.41									1747	1.45	6.70
	I-4800	1-3/4"	0.04	0.07	0.11	0.14	0.18	0.22	0.29	0.36	0.54								2007	1.45	6.70
	I-4000	1-3/4"	0.03	0.06	0.09	0.12	0.16	0.19	0.25	0.31	0.47								2330	1.45	6.70
60	I-6000	1-1/2"	0.12	0.24	0.35	0.47	0.59												940	2.21	6.77
	I-5500	1-1/2"	0.10	0.21	0.31	0.42	0.52	0.63											1058	2.21	6.77
	I-4800	1-1/2"	0.09	0.18	0.27	0.36	0.46	0.55											1215	2.22	6.77
	I-4000	1-1/2"	0.08	0.16	0.24	0.31	0.39	0.47	0.63										1410	2.21	6.77
	I-6000	1-3/4"	0.07	0.14	0.21	0.28	0.35	0.42	0.56										1258	1.77	6.77
	I-5500	1-3/4"	0.06	0.12	0.19	0.25	0.31	0.37	0.50										1415	1.77	6.77
	I-4800	1-3/4"	0.05	0.11	0.16	0.22	0.27	0.33	0.43	0.54									1626	1.77	6.77
	I-4000	1-3/4"	0.05	0.09	0.14	0.19	0.23	0.28	0.37	0.47									1887	1.77	6.77
66	I-6000	1-1/2"	0.17	0.34	0.52														777	2.67	6.80
	I-5500	1-1/2"	0.15	0.31	0.46	0.61													874	2.67	6.80
	I-4800	1-1/2"	0.13	0.27	0.40	0.53													1004	2.67	6.80
	I-4000	1-1/2"	0.11	0.23	0.34	0.46	0.57												1166	2.67	6.80
	I-6000	1-3/4"	0.10	0.20	0.31	0.41	0.51	0.61											1039	2.13	6.80
	I-5500	1-3/4"	0.09	0.18	0.27	0.36	0.45	0.55											1169	2.13	6.80
	I-4800	1-3/4"	0.08	0.16	0.24	0.32	0.40	0.48											1343	2.13	6.80
	I-4000	1-3/4"	0.07	0.14	0.20	0.27	0.34	0.41	0.55										1559	2.13	6.80
72	I-6000	1-1/2"	0.24	0.49															653	3.18	6.80
	I-5500	1-1/2"	0.22	0.43															735	3.18	6.80
	I-4800	1-1/2"	0.19	0.38	0.56														844	3.18	6.80
	I-4000	1-1/2"	0.16	0.32	0.49														980	3.18	6.80
	I-6000	1-3/4"	0.14	0.29	0.43	0.58													873	2.53	6.80
	I-5500	1-3/4"	0.13	0.26	0.39	0.52													982	2.53	6.80
	I-4800	1-3/4"	0.11	0.22	0.34	0.45	0.56												1128	2.53	6.80
	I-4000	1-3/4"	0.10	0.19	0.29	0.39	0.48	0.58											1310	2.53	6.80
78	I-6000	1-3/4"	0.20	0.40	0.60														744	2.97	6.80
	I-5500	1-3/4"	0.18	0.35	0.53														837	2.97	6.80
	I-4800	1-3/4"	0.15	0.31	0.46														962	2.97	6.80
	I-4000	1-3/4"	0.13	0.27	0.40	0.53													1116	2.97	6.80

NOTE: The black area () indicates at what point the load weight has ≤ 0.25" deflection.

NOTE: These tables represent the most popular series of DURAGRID® Phenolic. For all other series and sizes, contact your Strongwell representative.

DURAGRID® PHENOLIC GRATING CONCENTRATED LOAD / DEFLECTION

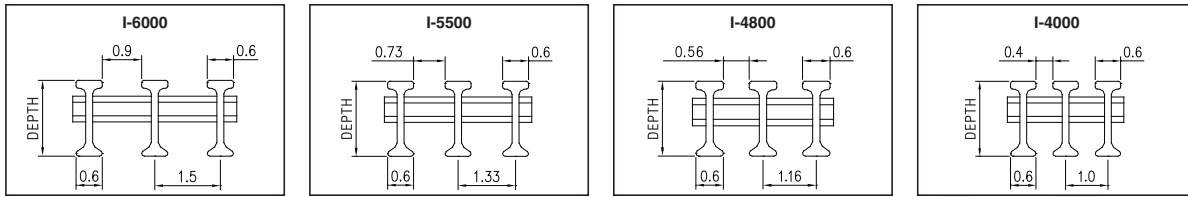

LOAD in LB / SQUARE FOOT (PSF)

SPAN INCHES	STYLE		LOAD in LB / SQUARE FOOT (PSF)													SAFE LOAD, 2:1 SAFETY FACTOR	DEFLECTION	E X 10 ⁶ PSI		
	SERIES	DEPTH	50	100	150	200	250	300	400	500	750	1000	2000	3000	4000				5000	6000
24	I-6000	1-1/2"	<0.01	0.01	0.01	0.01	0.02	0.02	0.02	0.03	0.05	0.06	0.12	0.18	0.25	0.31		5388	0.33	5.31
	I-5500	1-1/2"	<0.01	0.01	0.01	0.01	0.01	0.02	0.02	0.03	0.04	0.05	0.11	0.16	0.22	0.27	0.33	6,062	0.33	5.31
	I-4800	1-1/2"	<0.01	<0.01	0.01	0.01	0.01	0.01	0.02	0.02	0.04	0.05	0.10	0.14	0.19	0.24	0.29	6964	0.33	5.31
	I-4000	1-1/2"	<0.01	<0.01	0.01	0.01	0.01	0.01	0.02	0.02	0.03	0.04	0.08	0.12	0.16	0.21	0.25	8082	0.33	5.31
	I-6000	1-3/4"	<0.01	<0.01	0.01	0.01	0.01	0.01	0.01	0.02	0.03	0.04	0.07	0.11	0.15	0.18	0.22	7206	0.26	5.31
	I-5500	1-3/4"	<0.01	<0.01	<0.01	0.01	0.01	0.01	0.01	0.02	0.02	0.03	0.07	0.10	0.13	0.16	0.20	8107	0.26	5.31
	I-4800	1-3/4"	<0.01	<0.01	<0.01	0.01	0.01	0.01	0.01	0.01	0.02	0.03	0.06	0.09	0.11	0.14	0.17	9314	0.26	5.31
	I-4000	1-3/4"	<0.01	<0.01	<0.01	<0.01	0.01	0.01	0.01	0.01	0.02	0.02	0.05	0.07	0.10	0.12	0.15	10809	0.26	5.31
30	I-6000	1-1/2"	0.01	0.01	0.02	0.02	0.03	0.03	0.05	0.06	0.09	0.11	0.23	0.34	0.46			4702	0.54	5.60
	I-5500	1-1/2"	0.01	0.01	0.02	0.02	0.03	0.03	0.04	0.05	0.08	0.10	0.20	0.30	0.41	0.51		5,290	0.54	5.60
	I-4800	1-1/2"	<0.01	0.01	0.01	0.02	0.02	0.03	0.04	0.04	0.07	0.09	0.18	0.26	0.35	0.44	0.53	6077	0.54	5.60
	I-4000	1-1/2"	<0.01	0.01	0.01	0.02	0.02	0.02	0.03	0.04	0.06	0.08	0.15	0.23	0.30	0.38	0.46	7053	0.54	5.60
	I-6000	1-3/4"	<0.01	0.01	0.01	0.01	0.02	0.02	0.03	0.03	0.05	0.07	0.14	0.20	0.27	0.34	0.41	6288	0.43	5.60
	I-5500	1-3/4"	<0.01	0.01	0.01	0.01	0.02	0.02	0.02	0.03	0.05	0.06	0.12	0.18	0.24	0.30	0.36	7074	0.43	5.60
	I-4800	1-3/4"	<0.01	0.01	0.01	0.01	0.02	0.02	0.03	0.04	0.05	0.11	0.16	0.21	0.26	0.32		8127	0.43	5.60
	I-4000	1-3/4"	<0.01	<0.01	0.01	0.01	0.01	0.01	0.02	0.02	0.03	0.05	0.09	0.14	0.18	0.23	0.27	9432	0.43	5.60
36	I-6000	1-1/2"	0.01	0.02	0.03	0.04	0.05	0.06	0.07	0.09	0.14	0.18	0.37	0.55				3918	0.72	6.00
	I-5500	1-1/2"	0.01	0.02	0.02	0.03	0.04	0.05	0.07	0.08	0.12	0.16	0.33	0.49	0.65			4,408	0.72	6.00
	I-4800	1-1/2"	0.01	0.01	0.02	0.03	0.04	0.04	0.06	0.07	0.11	0.14	0.28	0.43	0.57			5064	0.72	6.00
	I-4000	1-1/2"	0.01	0.01	0.02	0.02	0.03	0.04	0.05	0.06	0.09	0.12	0.25	0.37	0.49	0.61		5877	0.72	6.00
	I-6000	1-3/4"	0.01	0.01	0.02	0.02	0.03	0.03	0.04	0.05	0.08	0.11	0.22	0.33	0.44	0.55		5240	0.57	6.00
	I-5500	1-3/4"	<0.01	0.01	0.01	0.02	0.02	0.03	0.04	0.05	0.07	0.10	0.19	0.29	0.39	0.49		5895	0.57	6.00
	I-4800	1-3/4"	<0.01	0.01	0.01	0.02	0.02	0.03	0.03	0.04	0.06	0.08	0.17	0.25	0.34	0.42	0.51	6773	0.57	6.00
	I-4000	1-3/4"	<0.01	0.01	0.01	0.01	0.02	0.02	0.03	0.04	0.05	0.07	0.15	0.22	0.29	0.37	0.44	7860	0.57	6.00
42	I-6000	1-1/2"	0.01	0.03	0.04	0.06	0.07	0.08	0.11	0.14	0.21	0.28	0.55					3358	0.93	6.34
	I-5500	1-1/2"	0.01	0.02	0.04	0.05	0.06	0.07	0.10	0.12	0.18	0.25	0.49					3,778	0.93	6.34
	I-4800	1-1/2"	0.01	0.02	0.03	0.04	0.05	0.06	0.09	0.11	0.16	0.21	0.43	0.64				4340	0.93	6.34
	I-4000	1-1/2"	0.01	0.02	0.03	0.04	0.05	0.06	0.07	0.09	0.14	0.18	0.37	0.55				5037	0.93	6.34
	I-6000	1-3/4"	0.01	0.02	0.02	0.03	0.04	0.05	0.07	0.08	0.12	0.16	0.33	0.49				4492	0.74	6.34
	I-5500	1-3/4"	0.01	0.01	0.02	0.03	0.04	0.04	0.06	0.07	0.11	0.15	0.29	0.44	0.59			5054	0.74	6.34
	I-4800	1-3/4"	0.01	0.01	0.02	0.03	0.03	0.04	0.05	0.06	0.10	0.13	0.25	0.38	0.51			5806	0.74	6.34
	I-4000	1-3/4"	0.01	0.01	0.02	0.02	0.03	0.03	0.04	0.05	0.08	0.11	0.22	0.33	0.44	0.55		6738	0.74	6.34

NOTE: The black area () indicates at what point the load weight has ≤ 0.25" deflection.
NOTE: These tables represent the most popular series of DURAGRID® Phenolic.
For all other series and sizes, contact your Strongwell representative.

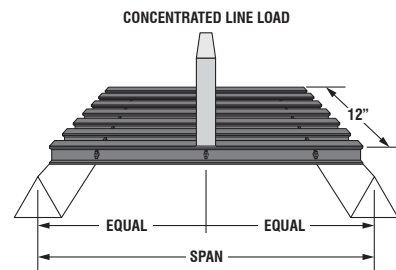

DURAGRID® PHENOLIC GRATING CONCENTRATED LOAD / DEFLECTION

SPAN INCHES	STYLE		50	100	150	200	250	300	400	500	750	1000	2000	3000	4000	5000	6000	SAFE LOAD, 2:1 SAFETY FACTOR	DEFLEC- TION	E X 10 ⁶ PSI
	SERIES	DEPTH																		
48	I-6000	1-1/2"	0.02	0.04	0.06	0.08	0.10	0.12	0.16	0.20	0.30	0.40						2939	1.16	6.60
	I-5500	1-1/2"	0.02	0.04	0.05	0.07	0.09	0.11	0.14	0.18	0.26	0.35						3,306	1.16	6.60
	I-4800	1-1/2"	0.02	0.03	0.05	0.06	0.08	0.09	0.12	0.15	0.23	0.31	0.61					3799	1.16	6.60
	I-4000	1-1/2"	0.01	0.03	0.04	0.05	0.07	0.08	0.11	0.13	0.20	0.26	0.53					4409	1.16	6.60
	I-6000	1-3/4"	0.01	0.02	0.04	0.05	0.06	0.07	0.09	0.12	0.18	0.24	0.47					3930	0.93	6.60
	I-5500	1-3/4"	0.01	0.02	0.03	0.04	0.05	0.06	0.08	0.10	0.16	0.21	0.42					4421	0.93	6.60
	I-4800	1-3/4"	0.01	0.02	0.03	0.04	0.05	0.05	0.07	0.09	0.14	0.18	0.37	0.55				5080	0.93	6.60
	I-4000	1-3/4"	0.01	0.02	0.02	0.03	0.04	0.05	0.06	0.08	0.12	0.16	0.31	0.47				5895	0.93	6.60
54	I-6000	1-1/2"	0.03	0.06	0.08	0.11	0.14	0.17	0.22	0.28	0.42	0.56						2612	1.45	6.70
	I-5500	1-1/2"	0.02	0.05	0.07	0.10	0.12	0.15	0.20	0.25	0.37	0.49						2,939	1.45	6.70
	I-4800	1-1/2"	0.02	0.04	0.06	0.09	0.11	0.13	0.17	0.21	0.32	0.43						3376	1.45	6.70
	I-4000	1-1/2"	0.02	0.04	0.06	0.07	0.09	0.11	0.15	0.19	0.28	0.37						3918	1.45	6.70
	I-6000	1-3/4"	0.02	0.03	0.05	0.07	0.08	0.10	0.13	0.17	0.25	0.33						3494	1.16	6.70
	I-5500	1-3/4"	0.01	0.03	0.04	0.06	0.07	0.09	0.12	0.15	0.22	0.29	0.59					3931	1.16	6.70
	I-4800	1-3/4"	0.01	0.03	0.04	0.05	0.06	0.08	0.10	0.13	0.19	0.26	0.51					4516	1.16	6.70
	I-4000	1-3/4"	0.01	0.02	0.03	0.04	0.06	0.07	0.09	0.11	0.17	0.22	0.44					5241	1.16	6.70
60	I-6000	1-1/2"	0.04	0.08	0.11	0.15	0.19	0.23	0.30	0.38	0.57							2351	1.77	6.77
	I-5500	1-1/2"	0.03	0.07	0.10	0.13	0.17	0.20	0.27	0.34	0.50							2,645	1.77	6.77
	I-4800	1-1/2"	0.03	0.06	0.09	0.12	0.15	0.18	0.23	0.29	0.44	0.58						3039	1.77	6.77
	I-4000	1-1/2"	0.03	0.05	0.08	0.10	0.13	0.15	0.20	0.25	0.38	0.50						3527	1.77	6.77
	I-6000	1-3/4"	0.02	0.04	0.07	0.09	0.11	0.13	0.18	0.22	0.34	0.45						3144	1.41	6.77
	I-5500	1-3/4"	0.02	0.04	0.06	0.08	0.10	0.12	0.16	0.20	0.30	0.40						3537	1.41	6.77
	I-4800	1-3/4"	0.02	0.03	0.05	0.07	0.09	0.10	0.14	0.17	0.26	0.35						4064	1.41	6.77
	I-4000	1-3/4"	0.01	0.03	0.04	0.06	0.07	0.09	0.12	0.15	0.22	0.30	0.60					4716	1.41	6.77
66	I-6000	1-1/2"	0.05	0.10	0.15	0.20	0.25	0.30	0.40	0.50								2137	2.14	6.80
	I-5500	1-1/2"	0.04	0.09	0.13	0.18	0.22	0.27	0.36	0.44								2,404	2.13	6.80
	I-4800	1-1/2"	0.04	0.08	0.12	0.15	0.19	0.23	0.31	0.39	0.58							2762	2.14	6.80
	I-4000	1-1/2"	0.03	0.07	0.10	0.13	0.17	0.20	0.27	0.33	0.50							3206	2.14	6.80
	I-6000	1-3/4"	0.03	0.06	0.09	0.12	0.15	0.18	0.24	0.30	0.45	0.60						2858	1.70	6.80
	I-5500	1-3/4"	0.03	0.05	0.08	0.11	0.13	0.16	0.21	0.26	0.40	0.53						3215	1.70	6.80
	I-4800	1-3/4"	0.02	0.05	0.07	0.09	0.12	0.14	0.18	0.23	0.35	0.46						3694	1.70	6.80
	I-4000	1-3/4"	0.02	0.04	0.06	0.08	0.10	0.12	0.16	0.20	0.30	0.40						4287	1.70	6.80
72	I-6000	1-1/2"	0.06	0.13	0.19	0.26	0.32	0.39	0.52									1959	2.54	6.80
	I-5500	1-1/2"	0.06	0.12	0.17	0.23	0.29	0.35	0.46	0.58								2,204	2.54	6.80
	I-4800	1-1/2"	0.05	0.10	0.15	0.20	0.25	0.30	0.40	0.50								2532	2.54	6.80
	I-4000	1-1/2"	0.04	0.09	0.13	0.17	0.22	0.26	0.35	0.43								2939	2.54	6.80
	I-6000	1-3/4"	0.04	0.08	0.12	0.15	0.19	0.23	0.31	0.39	0.58							2620	2.03	6.80
	I-5500	1-3/4"	0.03	0.07	0.10	0.14	0.17	0.21	0.27	0.34	0.52							2948	2.02	6.80
	I-4800	1-3/4"	0.03	0.06	0.09	0.12	0.15	0.18	0.24	0.30	0.45	0.60						3386	2.03	6.80
	I-4000	1-3/4"	0.03	0.05	0.08	0.10	0.13	0.15	0.21	0.26	0.39	0.52						3930	2.03	6.80
78	I-6000	1-3/4"	0.05	0.10	0.15	0.20	0.25	0.29	0.39	0.49								2419	2.38	6.80
	I-5500	1-3/4"	0.04	0.09	0.13	0.17	0.22	0.26	0.35	0.44								2721	2.38	6.80
	I-4800	1-3/4"	0.04	0.08	0.11	0.15	0.19	0.23	0.30	0.38	0.57							3127	2.38	6.80
	I-4000	1-3/4"	0.03	0.07	0.10	0.13	0.16	0.20	0.26	0.33	0.49							3629	2.38	6.80

NOTE: The black area () indicates at what point the load weight has ≤ 0.25" deflection.

NOTE: These tables represent the most popular series of DURAGRID® Phenolic. For all other series and sizes, contact your Strongwell representative.